

**RECOOP HST ASSOCIATION**

**Abstracts for pre-selection for  
the RECOOP Annual  
Scientific Review CMJ April  
issue in 2016  
74 abstracts**

## Table of Content

Total Number of abstracts: 75

Abstracts from RECOOP CRRC for CMJ (26)	#
<b>Croatia (2)</b>	
Osijek RECOOP CMJ Balog Aging Modifies Circulating Leptin and Leptin Receptors in Adrenal Gland	1
Osijek RECOOP CMJ Ivic Chronic stress effects on expression level of ObR and ER- $\beta$ in rat brain	2
<b>Czech (2)</b>	
HK Unive Hosp RECOOP CMJ M Kacerovsky Amniotic fluid granzym A in pregnancies	3
Prague IMMCH RECOOP CMJ Zanoska Functionalized porous maghemite&aminosilica core-shell NP	4
<b>Hungary (2)</b>	
Budapest RECOOP CMJ Dank Morphological and pathological prediction of disease free survival of breast cc patients	5
Budapest - Debrecen RECOOP CMJ fatty acid separation from adipose tissues	6
Szeged RECOOP CMJ Hajagos The effect of oestrogen on the expression and function of adrenergic receptor	7
<b>Slovakia (1)</b>	
Bratislava SMU RECOOP CMJ Testing the applicability of mod. swab meth. in enteroviral molecular diagnostics	8
<b>Ukraine ICB, Lviv (3)</b>	
ICB RECOOP CMJ Korchynskyi Mammalian Glycosilation protects citrullinated chemokines	9
ICB RECOOP CMJ Malysheva Osteogenesis in Mouse Mesenchymal Precursor Cells	10
ICB RECOOP CMJ Senkiv Alzheimer's Disease cannabinoid ligands as neuronal function novel modulators	11
ICB RECOOP Finiuk – Stoika Nano conjugated anticancer drug for glioblastoma	12
<b>Ukraine Palladin, Kyiv (1)</b>	
Palladin RECOOP CMJ Borisova Fluorescent and neuroactive properties of carbon dots	13
<b>Ukraine DHLNMU, Lviv (10)</b>	
DHLNMU RECOOP CMJ Bilous Nanoparticles for Treatment of Multi-Drug Resistant Tuberculosis	14
DHLNMU RECOOP CMJ Golota -Lesyk Search for antibacterial and antifungal agents	15
DHLNMU RECOOP CMJ Kaminsky Search for New Antifibrotic Agents among (amino)iminothiazolidinones	16

DHLNMU RECOOP CMJ Kobylinska The role of reactive oxygen species in mechanisms of novel anticancer drugs	17
DHLNMU RECOOP CMJ Kryshchyshyn - Lesyk 4-thiazolidinone derivatives Antitrypanosomal Activity	18
DHLNMU RECOOP CMJ Lozynskiy - Lesyk Investigations among thiazolo[4,5-b]pyridines anti cc and inflamm	19
DHLNMU RECOOP CMJ Shurpyak Gynecological Hyperplastic Syndrome	20
DHLNMU RECOOP CMJ Zayachkivska In silico approach of assessment stress-related score	21
DHLNMU RECOOP CMJ Zayachkivska_Pavlovsky Physiological aspects of H2S-aspirin on mucosa	22
DHLNMU RECOOP CMJ Zelisko - Lesyk Synthesis of potential antiviral agents	23

### **IKEM Czech Republic not identified for CMJ - RECOOP CRRC (3)**

Prague RECOOP CRRC Blahova Circadian activity of cholesterol 7 $\alpha$ -hydroxylase	24
Prague IKEM RECOOP CRRC Zemankova Glucose addition affects postprandial response of GLP-1	25
Prague IKEM RECOOP CRRC Jiratova Biological characteristics of a new glycogen-based nanocarriers	26

### **None RECOOP CRRC Abstracts: Ukraine DHLNMU, Lviv #**

#### **Cardiovascular (5)**

DHLNMU RECOOP CMJ Cherkas H. pylori in sedentary males is linked to higher heart rate	1
DHLNMU RECOOP CMJ Dzhililova Mitochondrial changes of cardiomyocytes streptozotocin diabetes	2
DHLNMU RECOOP CMJ Holtvyan Imbalance in Coronary Artery Calcification Missing ECA	3
DHLNMU RECOOP CMJ Korolyuk HbA1c levels above 5.7 % predicts CVD events in patients with CAD	4
DHLNMU RECOOP CMJ Pokotylo Long term opioid effects (7-14 days) in rats' myocardium	5

#### **Surgery (5)**

DHLNMU RECOOP CMJ Melnichuk Preventive Method of Pathological Scars Formation	1
DHLNMU RECOOP CMJ Ogurtsov New Method of Visualization in Laparoscopic Surgery	2
DHLNMU RECOOP CMJ Savchenko vascular surgery of tumors with invasion of the main vessels of the neck	3
DHLNMU RECOOP CMJ Verkhola Skin grafting and negative pressure wound therapy Missing ECA	4
DHLNMU RECOOP CMJ Pogranychna Cartilage and Bone Resorption in Trauma Injury of Temporo-mandib	5

**OBGYN (2)**

DHLNMU RECOOP CMJ Veresnyuk Bicornuate uterus Missing ECA	1
DHLNMU RECOOP CMJ Veresnyuk Hysteroscopy Missing ECA	2

**Clinical/ Miscellaneous (7)**

DHLNMU RECOOP CMJ Dats-Opoka Assosiation of extraesophageal displays Missing ECA	1
DHLNMU RECOOP CMJ Fuss Diagnostic criteria of necrotizing fasciitis in diabetes	2
DHLNMU RECOOP CMJ Kunovsky & Kvit Pain Syndrome in Patients with Acute Pancreatitis Missing ECA	3
DHLNMU RECOOP CMJ Strilchuk Echocardiographic parameters in helicobacter + and negative patients	4
DHLNMU RECOOP CMJ Yavorska Self-reported questionnaire for patients with suspected neuropathies	5
DHLNMU RECOOP CMJ Kostura V.L Prevalence of caries of permanent teeth in overweight children	6
DHLNMU RECOOP CMJ Gasiuk Gender Aspects of Human Molars' Enamel Missing ECA	7

**Pharmacology/Drug Development (8)**

DHLNMU RECOOP CMJ Kukuruza rheological characteristics of eye ointment	1
DHLNMU RECOOP CMJ Boretska Pharmacotherapy for Patients with Arterial Hypertension	2
DHLNMU RECOOP CMJ Gorodnycha problems associated with use of statins in Ukraine	3
DHLNMU RECOOP CMJ Kostyana Identification of drug-related problems in Migraine	4
DHLNMU RECOOP CMJ Lysiuk of Selenium Contents in Some Promising Nehroprotective Legume Plants	5
DHLNMU RECOOP CMJ Marshalok Synthesis and Biological Activity of 5-Substituted 1,4-Naphthoquinones	6
DHLNMU RECOOP CMJ Shunkina Methadone alternative analgesic for palliative patients	7
DHLNMU RECOOP CMJ Zorjana_Chaban Evaluation of Some Novel Thiazolo[4,3-b]quinazolines	8

**Translational Research (10)**

DHLNMU RECOOP CMJ Denysenko NO and lipid peroxidation in experimental colitis in rats	1
DHLNMU RECOOP CMJ Dudok Loratadine administration and morphology & lectin histochemistry of rat liver	2
DHLNMU RECOOP CMJ Hnydik Changes of hemomicrocirculatory flow of the mouth angle and lip in diabetes	3
DHLNMU RECOOP CMJ Ilkiv Cytoprotection of Small Intestine under Indometacin-Induced Injury	4

DHLNMU RECOOP CMJ Logash Changes in Antioxidant System, Lipid Peroxidation after Nalbuphine	5
DHLNMU RECOOP CMJ Matysik Cytotoxic Action of Hepatoprotector Antral on Bulls Sperm	6
DHLNMU RECOOP CMJ Pokotylo Haluk Hemo-microcirculatory vessel bed of white rat kidney in experimental diabetes	7
DHLNMU RECOOP CMJ Savka Morphometric analysis of bloodstream in white rat testis in diabetes	8
DHLNMU RECOOP CMJ Savytska Long-Term Treatment with M. Glutamate on Gastric Acid Secretion in Rat	9
DHLNMU RECOOP CMJ Malko Role of cytokines in development of chronic catarrhal gingivitis	10
<b>Microbiology (1)</b>	
DHLNMU Abstract Fik Research of microflora of the rat's oral cavity under the action of opioid	1
<b>Health Technology (1)</b>	
DHLNMU RECOOP CMJ Piniashko Usability and Advisability of Health Technology Assessment	1
<b>None RECOOP CRRC Abstracts: Ukraine DHLNMU, Lviv</b>	<b>#</b>
<b>Out of the Scope of RECOOP Research Strategy: Common Mechanism of Diseases</b>	
<b>Dentistry (11)</b>	
DHLNMU RECOOP CMJ Abstract Melnyk Evaluation of Dental Status of Children	1
DHLNMU RECOOP CMJ Bandrivsky Generalized Periodontitis with Different Blood types	2
DHLNMU RECOOP CMJ Dyrkyk Patients with Inflammatory Periodontal Diseases Missing ECA	3
DHLNMU RECOOP CMJ Lychkovska Photoactivation disinfection in Periodontology	4
DHLNMU RECOOP CMJ Magera Normalization of functional dental occlusion	5
DHLNMU RECOOP CMJ Miskiv.A.L. The Structure of Dentomaxillary Anomalies	6
DHLNMU RECOOP CMJ Riznyk Vasocorrective Therapy of Patients with Generalized Periodontitis	7
DHLNMU RECOOP CMJ Sloboda Condition of periodontal tissues in young person	8
DHLNMU RECOOP CMJ Sorokivsky Asymmetry in light conductivity of the maxillary sinuses	9
DHLNMU RECOOP CMJ Holeyko periodontal status of the patients with endo-perio lesions	10
Uzhgorod RECOOP CMJ Horzov Dental Status of Children in Territories with Low Fluoride	11

**Additional submission**

**RECOOP CRRC Abstracts: Ukraine ICB, Lviv**

ICB Lviv RECOOP CMJ Panchuk Antioxidants modulate anticancer effects 1

**RECOOP CRRC Abstracts: Ukraine Palladin, Kiev**

Palladin RECOOP CMJ Borysov Cholesterol depletion of nerve terminals 1

Palladin RECOOP CMJ Dekaliuk Carbon nanoparticles fluorescent probes for apoptosis 2

Palladin RECOOP CMJ Hudz An inhibitory action on aggregation of human platelets 3

Palladin RECOOP CMJ Kasatkina Glutamate regulates platelet release reactions 4

Palladin RECOOP CMJ Mazur Plasma membrane Ca<sup>2+</sup>-pump selective regulators 5

Palladin RECOOP CMJ Pasichnyk Mechanisms in the development of drug resistance 6

Palladin RECOOP CMJ Stohniy Mapping of Residues Fibrinog. Cleaved by Protease II 7

Palladin RECOOP CMJ Urvant Localization of the site of fibrin protofibrils 8

Palladin RECOOP CMJ Zaitseva Effect of BCG on Bone Struct. & Metabolism in Rats 9

**Abstracts from RECOOP  
CRRC for CMJ  
22**

## Sex-specific Chronic Stress Response and Aging Modifies Circulating Leptin and Leptin Receptors in Adrenal Gland

Balog M<sup>1</sup>, Ivić V<sup>1</sup>, Labak I<sup>1</sup>, Zelen A<sup>1</sup>, Seres A<sup>2</sup>, Szűcs K<sup>2</sup>, Fagyas M<sup>3</sup>, Borbély A<sup>3</sup>, Papp Z<sup>3</sup>, Vari SG<sup>4</sup>, Gaspar R<sup>2</sup>, Heffer M<sup>1</sup>

<sup>1</sup> University of Osijek, Faculty of Medicine, Croatia

<sup>2</sup> Department of Pharmacodynamics and Biopharmacy, University of Szeged, Hungary

<sup>3</sup> University of Debrecen, Faculty of Medicine, Institute of Cardiology, Debrecen, Hungary

<sup>4</sup> International Research and Innovation in Medicine Program, Cedars-Sinai Medical Center, Los Angeles, CA, USA

Corresponding author: Marija Heffer, [mheffer@gmail.com](mailto:mheffer@gmail.com)

**Key words:** chronic stress, aging, leptin, leptin receptor, adrenal gland

**Introduction:** Chronic stress promotes long term changes, which can lead to a variety of diseases. Aging puts additional pressure on entire body, especially on maintenance of stress regulating organs. Aim of this study was to compare serum leptin and leptin receptors (Ob-R) changes in the adrenal gland of Sprague Dawley rats upon chronic stress and aging.

**Methods:** Rats were divided into males and females and subdivided in castrated/ovariectomized (CAST/OVX) and non-castrated/ovariectomized groups (NCAST/NOVX). Half of the animals was subjected to chronic stress and half was sham stressed (CHR/SH) through three repeats of 10-day stress sessions. Serums were collected at baseline and before sacrificing. Leptin concentration was measured using a rat leptin ELISA kit. Adrenal glands were collected from 17-and-a-half-months old animals and immunohistochemical staining of adrenal gland against Ob-R was performed. Images were photographed using Zeiss Axioskop 2 MOT microscope and analyzed in ImageJ software. Statistical analysis were performed in SPSS software.

**Results:** NOVX-CHR group had lower expression of Ob-R than OVX-CHR group ( $p=0.006$ ). NCAST-SH animal group showed higher expression of Ob-R than NCAST-CHR group ( $p=0.011$ ). CAST-CHR had higher leptin serum concentration at baseline as well as after third stress session than their controls ( $p=0.03$ ,  $p=0.017$ , respectively). CAST-CHR had higher leptin serum concentration than NCAST-CHR group at baseline and after third stress session ( $p=0.022$ ,  $p=0.001$ ). Males had an increase in serum leptin in all groups after third stress session compared to baseline values of all male groups, but the opposite trend was observed in females. Females showed the same trend of serum leptin and Ob-R expression in adrenal cortex. This effect was most noticeable in the case of female chronic stress groups with NOVX-CHR group having lower values of serum leptin after third stress session and lower Ob-R expression in adrenal gland (serum leptin:  $p=0.01$ ; ObR expression in adrenal gland:  $p=0.006$ ). Overall the level of Ob-R in adrenal cortex is higher if sexual hormones are deprived.

**Conclusion:** Chronic stress increases leptin level in serum of aged rats in the case of sexual hormone deprivation. Similar increase was observed in adrenal gland leptin receptor immunostaining. Leptin is required for energy balance therefore further studies would reveal if the observed changes lead to cell proliferation, differentiation or apoptosis.

**Acknowledgements:** This study was supported by Cedars Sinai Medical Center's International Research and Innovation in Medicine Program, the Association for Regional Cooperation in the Fields of Health, Science and Technology (RECOOP HST Association), Hungarian Scientific Research Fund (OTKA PD 108614), co-financed by the European Social Fund in the framework of TÁMOP 4.2.4. A/2-11-1-2012-0001 "National Excellence Program" and internal research grant from J. J. Strossmayer University of Osijek, Croatia. The study was performed at the Department of Pharmacodynamics and Biopharmac, University of Szeged, Hungary during July 2014 – February 2015.

Ethical Committee or Institutional Animal Care and Use Committee Approval: Ethical Committee of the Croatian Ministry of Agriculture; approval number: 2158-61-07-11-51, Hungarian Ethical Committee for Animal Research; approval number: IV./37961/2015.



## **Chronic stress affects the expression level of ObR and ER- $\beta$ in the brain of adult female Sprague-Dawley rats**

Ivić, V.<sup>1</sup>, Labak, I.<sup>2</sup>, Balog, M.<sup>1</sup>, Blažetić, S.<sup>2</sup>, Vondrak, L.<sup>2</sup>, Vari, S. G.<sup>3</sup>, Heffer, M.<sup>1,\*</sup>

<sup>1</sup> Josip Juraj Strossmayer University of Osijek, Faculty of Medicine Osijek, Department of Medical Biology and Genetics, Cara Hadrijana 10/E, HR-31000 Osijek, Croatia

<sup>2</sup> Josip Juraj Strossmayer University of Osijek, Department of Biology, Cara Hadrijana 8/A, HR-31000 Osijek, Croatia

<sup>3</sup> International Research and Innovation in Medicine Program, Cedars–Sinai Medical Center, Los Angeles, CA, USA

\*Corresponding author: Marija Heffer, MD, PhD ([mheffer@mefos.hr](mailto:mheffer@mefos.hr))

**Keywords:** Brain, chronic stress, leptin receptor, estrogen-beta receptor

**Introduction:** Chronic stress causes diverse molecular changes for the sake of homeostasis maintenance. It can ultimately lead to life-threatening disorders such as cardiovascular and metabolic disease characterized by high blood pressure, obesity and hormonal dysfunction.

**Methods:** To understand the impact of chronic stress on the level of leptin receptor (ObR) and steroid hormone receptors in the brain, female Sprague-Dawley rats were exposed to different stressors within 3 stress sessions followed by 2-week-pause in between. Overall 32 4-months-old rats were divided in non-ovariectomized (NON-OVX) and ovariectomized (OVX) group. These groups were subdivided in chronic (CHS) and control group (CTR). Controls were in the same conditions as stress groups, but without stressor. The brains were collected after the last stress session and free-floating immunohistochemical staining was performed using ObR, progesterone (PR) and estrogen- $\beta$  receptor (ER- $\beta$ ) antibodies. The level of receptors expression was analyzed in hippocampus (HIPP), hypothalamic regions (HTH) and cortical areas (CTX).

**Results:** After exposure to stress, ObR expression in NON-OVX-S decreased in all brain regions except in HIPP, while in OVX-S increased, but it was not a significant change. Also we observed no significant changes in PR expression. However, during CHS the ER- $\beta$  level significantly decreased in OVX-S animals' HTH (S vs. C,  $P=0.05$ ). Although NON-OVX-S vs. OVX-S animal groups significantly lower levels ER- $\beta$  ( $P=0.017$ ) in HIPP were recorded.

**Discussion and Conclusion:** In NON-OVX-S animals the exposure to chronic stress decreased ObR expression in HTH involved in appetite control and increased in HIPP. For this reason the CHS animals become less susceptible to leptin and consequently may gain weight. At the same time they also have estrogen neuroprotection, particularly important for HIPP. In case of ovary removal, upon exposure to stress OVX animals increase ObR level in HTH and HIPP, on the contrary fail to increase ER- $\beta$  like NON-OVX-S. Thus OVX animals become more susceptible to leptin and lose estrogen neuroprotection what endangers overall their stress resistance.

**Acknowledgement:** The study was supported by Cedars-Sinai Medical Center's International Research and Innovation in Medicine Program and the Association for Regional Cooperation in the Fields of Health, Science and Technology (RECOOP HST Association). It has been funded by internal research grant from J. J. Strossmayer University of Osijek, Osijek, Croatia, and approved by the Ethical Committee of the Faculty of Medicine Osijek, approval number: 2158-61-07-11-51.

## **Amniotic fluid granzym A in pregnancies complicated by preterm prelabor rupture of the membranes**

Bestvina T.<sup>1</sup>, Stepan M.<sup>1</sup>, Andrys C.<sup>2</sup>, Musilova I.<sup>1</sup>, and Kacerovsky M.<sup>1,3</sup>

<sup>1</sup>Department of Obstetrics and Gynecology, Charles University in Prague, Faculty of Medicine Hradec Kralove, Hradec Kralove, Czech Republic;

<sup>2</sup> Department of Immunology and Allergy, Charles University in Prague, Faculty of Medicine Hradec Kralove, Hradec Kralove, Czech Republic.

<sup>3</sup>Biomedical Research Center, University Hospital Hradec Kralove, Hradec Kralove, Czech Republic.

Corresponding author: Marian Kacerovsky, MD, PhD, Email: [kacermar@fnhk.cz](mailto:kacermar@fnhk.cz)

**Key words:** Preterm delivery; inflammation; infection; bacteria

**Introduction:** Preterm prelabor rupture of membranes (PPROM) is often complicated by the presence of microbial invasion of the amniotic cavity (MIAC) and intraamniotic inflammation (IAI). A robust marker for a prediction of these complication has yet to be found.. Granzym A has been traditionally considered as a cell death initiator, however, its primary role seems to be to promote pro-inflammatory cytokine production. There is a paucity of information about its role in the process of intraamniotic inflammation. Therefore, the main aim of this study was to evaluate granzym A concentrations in the amniotic fluid from PPRM pregnancies with respect to the presence of MIAC, IAI, and microbial-associated IAI.

**Methods:** One hundred sixty-eight women with singleton pregnancies were included in this study. Amniotic fluid samples were obtained by transabdominal amniocentesis and were assayed for granzym A levels by ELISA. IAI was defined as amniotic fluid interleukin-6 > 745 pg/mL. Microbial-associated IAI was defined as the presence of both MIAC and IAI.

**Results:** Amniotic fluid granzym A concentrations were measurable in all samples. MIAC and IAI were present in 31% (52/168) and 20% (34/168) of women, respectively. Microbial-associated IAI was found in 15% (26/168) of women. No differences in granzym A concentrations were found between women with and without MIAC (with MIAC: median 16.6 ng/mL vs. without MIAC: median 19.9 ng/mL;  $p=0.09$ ). Neither women with IAI nor with microbial-associated IAI had different amniotic fluid granzym A concentrations than women without these conditions (with IAI: median 18.3 ng/mL, range 0.2-127.1 vs. without IAI: median 18.7 ng/mL;  $p=0.92$ ; with microbial-associated IAI: median 16.6 ng/mL, vs. without microbial-associated IAI: median 19.9 ng/mL;  $p=0.17$ ).

**Conclusion:** Granzym A, which is a physiologic constituent of the amniotic fluid in women with PPRM, does not play a role in the infectious and inflammatory complications associated with PPRM.

### **Declaration of interest statement**

This work was supported by Charles University in Prague, Faculty of Medicine in Hradec Kralove, Czech Republic, project “PRVOUK” P37/10 and Faculty Hospital in Hradec Kralove (long-term organization development plan).

**Ethical Committee Approval:** The study was approved by the Institutional Review Board committee (March 19, 2008 No 200804 SO1P), and informed consent was received from all participants.

# Functionalized porous maghemite&aminosilica core-shell nanoparticles for applications in medicine: Design, synthesis and immunotoxicity tests

Zasońska B. A.<sup>1</sup>, Líšková A.<sup>2</sup>, Tulinská J.<sup>2</sup>, Kuricová M.<sup>2</sup>, Horák D.<sup>1</sup>

<sup>1</sup> *Department of Polymer Particles, Institute of Macromolecular Chemistry, Academy of Sciences of the Czech Republic, Heyrovský Sq. 2, 162 06 Prague 6, Czech Republic*

<sup>2</sup> *Laboratory of Immunotoxicology, Slovak Medical University, Limbova 14, 833 03 Bratislava, Slovakia*

Corresponding author: [horak@imc.cas.cz](mailto:horak@imc.cas.cz)

**Keywords:** core-shell maghemite nanoparticles, proliferative activity of lymphocytes, phagocytic activity, respiratory burst, granulocyte macrophage colony stimulating factor

**Introduction:** Modified magnetic iron oxide nanoparticles (MNPs) receive a great deal of attention in many bioapplications due to interesting magnetic properties. Aim of this study was to synthesize silica-coated MNPs and investigate their cytotoxicity and effect on immune response: lymphocyte proliferative and phagocytic activity, leukocyte respiratory burst, and *in vitro* production of cytokine granulocyte macrophage colony stimulating factor (GM-CSF).

**Methods:** Maghemite ( $\gamma\text{-Fe}_2\text{O}_3$ ) MNPs were prepared by coprecipitation of iron salts with ammonia followed by controlled oxidation with NaOCl. MNPs were modified by tetramethyl orthosilicate and (3-aminopropyl)triethoxysilane. Coated MNPs were characterized by SEM and TEM, dynamic light scattering, FT IR, elemental analysis, EDAX and XPS. Finally, proliferative activity of lymphocytes was assessed using  $^3\text{H}$ -thymidine incorporation into DNA of proliferating cells. Phagocytic activity and respiratory burst of leukocytes were examined by flow cytometry. Levels of GM-CSF in cell supernatants were analyzed by ELISA.

**Results and Discussion:** Diameter of starting MNPs, which formed a stable aqueous colloid, was ~10 nm. After modification with aminosilica, the size increased to ~30 nm. No cytotoxic effect of MNPs (concentration 0.12–75  $\mu\text{g}/\text{cm}^2$ ) was found when measured as incorporation of [ $^3\text{H}$ ]-thymidine into DNA of proliferating peripheral blood cells. Proliferative activity of T-lymphocytes and T-dependent B-cell response did not change in cultures exposed to MNPs when compared to controls. No marked effect of MNPs on phagocytic activity of granulocytes, monocytes and respiratory burst of phagocytic cells was observed. Cytokine GM-CSF levels increased in cell cultures exposed to high MNP dose (75  $\mu\text{g}/\text{cm}^2$ ). GM-CSF production increased in cultures treated with 3–75  $\mu\text{g}/\text{cm}^2$  and was stimulated with pokeweed mitogen.

**Conclusions:** New core-shell MNPs were synthesized and their immunotoxicity determined. As the toxicity was minimal, the particles can be useful for biomedical applications, such as in biosensors, cell labelling and magnetic resonance imaging, or in drug delivery systems.

**Acknowledgement:** We thank Helena Nagyová and Edita Mrvíková for technical help. Support of the Ministry of Education, Youth and Sports of the Czech Republic (LH14318) and RECOOP HST Association and the Cedars-Sinai Medical Center is acknowledged. We also acknowledge the support of the European Commission 7<sup>th</sup> FP for the QualityNano project (FP7 INFRA-2010-1.1.31, contract No. 214547-2) and for NanoTEST project (Health-2007-1.3-4, contract No. 201335). This article was also supported by the ITMS project No. 26240120033, Operational research and development program financed from the European Regional Development Fund.

## **Morphological and pathological response in primary systemic therapy of patients with breast cancer and the prediction of disease free survival**

Szentmártoni G [1]\*, Tóké AM [2]\*, Tóké T [1], Somlai K [3], Szász A M [2], Torgyík L [1], Kulka J [2], Dank M [1]#

[1] Semmelweis University 1st Dept. of Internal Medicine, Oncology Division, Budapest, Hungary

[2] 2nd Department of Pathology, Budapest, Hungary

[3] Surgical Division of St. Margit Hospital, Budapest

\* Both authors have contributed equally to this work

# corresponding author: Magdolna Dank, e-mail [dank.oncology@gmail.com](mailto:dank.oncology@gmail.com)

**Keywords:** breast cancer subtypes, primary systemic therapy, ultrasound, physical examination

**Introduction:** This study aimed to identify breast cancer subtypes likely to respond to primary systemic therapy (PST) and to assess the accuracy of physical examination (PE) and breast ultrasonography (US) in evaluating and predicting residual size of breast carcinoma following PST.

**Methods:** A prospectively collected clinical database was analyzed. 116 patients were included who received PST between 1998 and 2009. Radiological assessment was done by mammography and US (PET/CT and MRI were only available in the second part of the analyzed period therefore not considered hereby). Prior to PST, core biopsy (NCB) and/or fine-needle aspiration based immunohistochemical profiles of NCB subclassified the tumors. Pathological response rates were assessed following the surgeries by using Chevallier classification. Tumor measurements by PE and US were obtained before and after PST. Different clinical measurements were compared with histology. Disease-free survival (DFS) was assessed.

**Results:** Pathological complete remission (pCR=Chevallier I/II) was observed in 25 cases (21.5%), amongst them triple negative histology dominated (44%), percent of high grade tumor was 76%. Of 116 patients, 24 received taxane-based PST, 48 combined taxane+anthracycline treatment, 8 trastuzumab combinations, 21 antracyclin based treatment, and 15 other were administered. In the taxane treated group the pCR rate was 30%, in the taxane+anthracycline group 25%, in the anthracycline group 9.5% and in trastuzumab group 37.5%. After PST, PE correlated better with pathology than US ( $p=0.00001$  and  $p=0.0047$ , respectively). Concerning DFS, significant difference was observed between the Chevallier III and IV group ( $p=0.0313$ ). In the pCR group fewer events were observed during the follow-up period.

**Discussion and conclusions:** It seems that even limited, routinely used immunohistochemical profiling of tumors is able to predict the likelihood of pCR to PST: patients with triple negative and Her2-positive cancers are more likely to achieve pCR after PST. PE correlates with the pathological findings better than US.

**Conflict of interest:** The authors declare that they have no conflict of interest.

**Funding:** none was involved.

**Ethical Committee Approval:** Ethical approval for the study was given by the Semmelweis University Institutional Review Board. Date and number of the ethical approval: 76/2007.

## **Effect of diet and physical activity in animal model on fatty acid composition of adipose tissue.**

*In memoriam of János Harangi, University of Debrecen, Hungary*

Nagy É<sup>1</sup>, Krivošíková Z<sup>2</sup>, Gajdoš M<sup>2</sup>, Kebis A<sup>3</sup>, Has-Schön E<sup>4</sup>, Szökő É<sup>5</sup>, Vari SG<sup>6</sup>, Tábi T<sup>5</sup>

<sup>1</sup>Doctorate School of Animal Husbandry, Faculty of Agriculture and Nutritional Sciences  
University of Debrecen, Hungary

<sup>2</sup>Department of Clinical and Experimental Pharmacotherapy, Medical faculty, Slovak Medical  
University, Bratislava, Slovakia

<sup>3</sup>Faculty of Public Health, Slovak Medical University in Bratislava

<sup>4</sup>Department of Biology, University of Osijek, Osijek, Croatia;

<sup>5</sup>Department of Pharmacodynamics, Faculty of Pharmacy, Semmelweis University, Hungary

<sup>6</sup>International Research and Innovation in Medicine Program, Cedars - Sinai Medical  
Center, Los Angeles, CA, USA

Corresponding author: Dr. Tamás Tábi, PhD [tabi.tamas@pharma.semmelweis-univ.hu](mailto:tabi.tamas@pharma.semmelweis-univ.hu)

**Keywords:** fatty acid composition, high fat diet, physical exercise

**Introduction:** Adipose tissue contains triglycerides of various fatty acids. Among them the most abundant saturated and monounsaturated ones serve mainly as energy storage while the polyunsaturated ones are the precursors of a range of mediators such as prostanoids and leukotrienes. Different polyunsaturated fatty acids are metabolized to mediators with different biological activities. Significant evidence has been accumulated to support the cardiovascular protective role of n-3 fatty acids compared to n-6 ones.

**Aims:** In this study we aim at analyzing fatty acid composition in visceral and subcutaneous adipose tissue of rats in response to diet and physical activity.

**Methods:** High-fat diet was used to induce obesity in rats. A subgroup of rats was forced to running to mimic physical exercise while another subgroup was also fed by antioxidant selenized cookie. Fatty acid composition of white adipose tissue was measured by gas chromatography after transesterification.

**Results:** High-fat diet significantly increased the saturated and monounsaturated fatty acid content of both the visceral and subcutaneous adipose tissue, while the polyunsaturated fatty acid content decreased significantly in both tissues contrary its relatively high intake. Physical exercise was found unable to reverse the effect of high-fat intake. Antioxidant intake slightly increased the polyunsaturated fatty acid levels, however its effect was rather limited.

**Conclusion:** Our data showed that diet rich in fat has detrimental effect on adipose tissue fatty acid composition. Lifestyle interventions are hardly effective in reversing the effect of high fat diet.

**Ethical approval:** The proposal was approved by the Ethical Committee for Animal Experiment of the Slovak Medical University and by the State Veterinary and Food Authority of the Slovak Republic (Ro-1651/11-221b).

**Acknowledgement:** This study was supported by Cedars Sinai Medical Center's International Research and Innovation in Medicine Program, the Association for Regional Cooperation in the Fields of Health, Science and Technology (RECOOP HST Association) and "Center of excellence of environmental health" project, ITMS No.24240120033, based on the supporting operational Research and development program financed from the European Regional Development Fund.

## The effect of oestrogen on the expression and function of the different alpha2-adrenergic receptor subtypes in late pregnant rat myometrium

Judit Hajagos-Tóth<sup>1</sup>, Judit Bóta<sup>1</sup>, Eszter Ducza<sup>1</sup>, Reza Samavati<sup>2</sup>, Sándor Benyhe<sup>2</sup>, Anna Borsodi<sup>2</sup>, Róbert Gáspár<sup>1</sup>

<sup>1</sup> Department of Pharmacodynamics and Biopharmacy, University of Szeged, Szeged, Hungary

<sup>2</sup> Institute of Biochemistry, Biological Research Centre, Szeged, Hungary

Corresponding author: Róbert Gáspár, [gaspar@pharm.u-szeged.hu](mailto:gaspar@pharm.u-szeged.hu)

**Key words:** adrenergic system, oestrogen, pregnancy, myometrium, noradrenaline

**Introduction:** The adrenergic system and oestrogen play a major role in the control of uterine function. The alpha2A- and alpha2C-adrenergic receptors decrease the contractile response to noradrenaline, while the alpha2B-adrenergic receptors mediate contractions. Our aims were to clarify the change in function and expression of the alpha2-adrenergic receptor subtypes after oestrogen pre-treatment in late pregnancy.

**Methods:** SPRD rats from pregnancy day 18 were treated with oestrogen for 4 days. The myometrial expressions of the alpha2-adrenergic receptor subtypes were determined by RT-PCR. *In vitro* contractions were stimulated with noradrenaline, and its effect was modified with the selective antagonists BRL 44408 (alpha2A), ARC 239 (alpha2B/C) and spiroxatrine (alpha2A). The accumulation of cAMP was also measured. The activated G-protein level was investigated by GTP binding assay.

**Results:** Oestrogen pre-treatment decreased the contractile effect of noradrenaline in the presence of all the alpha2-adrenergic receptor subtype antagonists and BRL 44408 + spiroxatrine combination (by 75%), which means decreased contractile response through the alpha2B-adrenergic receptors. All of the alpha2-adrenergic receptor subtypes mRNA was decreased. BRL 44408 (\*\*P < 0.001), ARC 239 (\*\*P < 0.01) and spiroxatrine (\*P < 0.05) increased the uterine cAMP level, however, there were no changes after the BRL 44408 – spiroxatrine combination. Oestrogen pre-treatment decreased the G-protein-activating effect of noradrenaline by 25% in the presence of BRL 44408 – spiroxatrine combination.

**Conclusions:** Our results suggest that the expressions of the alpha2-adrenergic receptor subtypes are oestrogen sensitive. In addition, oestrogen decreases the contractile response of noradrenaline through the alpha2-adrenergic receptor subtypes, and increases the uterine cAMP level in the presence of BRL 44408, ARC 239 and spiroxatrine, which might contribute to the decreased myometrial contraction through the alpha2A- and alpha2C-ARs.

**Acknowledgements:** The study was supported by a grant from the National Research, Development and Innovation Office (NKFI), Budapest, Hungary; grant identifier is OTKA-108518.

**Ethical Committee or Institutional Animal Care and Use Committee Approval:** All experiments involving animal subjects were carried out with the approval of the Hungarian Ethical Committee for Animal Research (permission number: IV/198/2013).

## Testing the applicability of modified swab method in enteroviral molecular diagnostics

Borsanyiova M<sup>a</sup>, Sarmirova S<sup>a</sup>, Puljak L<sup>b</sup> Britt W<sup>c</sup>, Bopegamage S<sup>a</sup>, Vari SG<sup>d</sup>

<sup>a</sup>Enterovirus Laboratory, Faculty of Medicine, Slovak Medical University, Bratislava, Slovak Republic

<sup>b</sup>Department of Anatomy, Histology and Embryology, School of Medicine, University of Split, Split, Croatia

<sup>c</sup>Department of Pediatrics, Microbiology, Neurobiology, University of Alabama at Birmingham, Birmingham

<sup>d</sup>The International Research and Innovation in Medicine Program, Cedars-Sinai Medical Center, Los Angeles, California, USA

Corresponding author's e-mail: sandor.vari@cshs.org

**Key words:** Enteroviruses, dry-swabs, feasibility, PCR, diagnosis.

**Introduction:** Traditionally throat swabs used in diagnosis of enteroviruses are collected in virus transfer medium. Air-dry or frozen swab may be convenient for the clinicians and for transport. We have modified the air-dried/frozen swab method without the virus transfer medium in our laboratory. The applicability of the method for use for clinical sample collection, transport and testing has to be explored.

**Aim** To test the feasibility of air-dried/frozen swabs without transport medium, in the screening of enterovirus infections in a small study group.

**Methods** Buccal swabs were collected (two per person) from 37 volunteers (participants of international RECOOP HST Association meeting). Institutional approval and informed consents were obtained from each participant. One swab was frozen immediately at -80°C, second air-dried and subsequently frozen at -80°C. Samples were transported on dry ice to Enterovirus laboratory (Slovakia), vortexed in 300µl RNase free water, after 20 min incubation at room temperature. Swabs were discarded and extract was frozen at -80°C until use. Viral RNA extraction and two step reverse transcriptase PCR were conducted.

**Results:** Enteroviral RNA was found in 16.22% (6/37) swabs of the enrolled volunteers. Results of both the treatments were comparable. Positive samples were random in different countries. We did not observe increased incidence of enteroviral infections at the time of the conference.

**Discussion:** We were successful in showing the presence of viral RNA in the air-dried and frozen buccal swabs. The transport of the clinical samples from Croatia to Slovakia on dry ice was feasible.

**Conclusion** Collection of clinical samples in the form of dried/frozen swabs without transport medium maybe used for diagnosis/screening of EV infections.

**Acknowledgements:** financed by National Reference Center of the Enterovirus Laboratory, from the Slovak Ministry of Health budget.

Supported by The Regional Cooperation for Health, Science and Technology (RECOOP HST) Association, Norwegian Financial Mechanism, Mechanism EEA and Slovak Government and the State Budget of the Slovak Republic (SK 0082), and Center of excellence of environmental health, ITMS No.24240120033.

**Ethical Committee Approval:** The Slovak Medical University Ethical Committee issued the approval on 25.2.2015

## Glycosylation in Mammals Protects Citrullinated Chemokines from Partial Degradation

\*<sup>1,2</sup>Korchynskiy O., \*<sup>3</sup>Yoshida K., <sup>2</sup>Speijer D., <sup>2</sup>Tak P.P., <sup>3</sup>Isozaki T., <sup>3</sup>Ruth J.H., <sup>3</sup>Campbell P.L., <sup>3</sup>Amin M.A., and <sup>3,4</sup>Koch A.E.

<sup>1</sup>Institute of Cell Biology, National Academy of Sciences of Ukraine, Lviv, Ukraine.

<sup>2</sup>Academic Medical Center/University of Amsterdam, Amsterdam, Netherlands,

<sup>3</sup>University of Michigan Medical School, Division of Rheumatology and <sup>4</sup>VA Medical Service, Department of Veterans Affairs Medical Center, Ann Arbor, Michigan, USA,

\*These authors contributed equally

**Keywords:** Chemokine, citrullination, glycosylation, rheumatoid arthritis.

**Introduction:** Citrullination is a posttranslational modification of some specific proteins by peptidylarginine deiminase (PAD) activities. Nowadays citrullination is recognized as a hallmark of rheumatoid arthritis and other autoimmune diseases. In our recent study we have shown a presence of citrullinated chemokines epithelial-derived monocyte chemoattractant protein-1 (MCP-1/CCL2), macrophage inflammatory protein-1 $\alpha$  (MIP-1 $\alpha$ /CCL3) and neutrophil-activating peptide 78 (ENA-78/CXCL5) in biological fluids collected from patients suffering from rheumatoid arthritis (RA) versus non-autoimmune arthritis diseases and demonstrated citrullinated ENA-78/CXCL5 as an efficient macrophage chemoattractant in a contrast with non-citrullinated ENA-78/CXCL5. In our current work we found that citrullinated *in vitro* bacterially produced chemokines cannot be efficiently used as the standards in modified enzyme linked immunosorbent assay (ELISA) assays designed to detect citrullinated chemokines. Such a result primed a *hypothesis that posttranslational modifications occurring in mammalian cells that can stabilize chemokines can also protect citrullinated chemokines from quick degradation.*

**Methods:** MCP-1/CCL2 and MIP-1 $\alpha$ /CCL3 were cloned from total RNA isolated from synovial fibroblasts obtained from RA patient. Both bacterially-produced and mammalian cells-produced recombinant human chemokines were citrullinated by commercial rabbit PAD2. Success in citrullination was confirmed with Western blotting and mass-spectrometry. Citrullinated chemokine concentrations were measured by modified sandwich ELISA assays.

**Results and Discussion:** Both commercially available and self-made bacterially produced chemokines MCP-1/CCL2, MIP-1 $\alpha$ /CCL3 and ENA-78/CXCL5 undergo quick partial degradation upon their *in vitro* citrullination by PAD2 and cannot be detected with either Western blotting or mass-spectrometry. At the same time mammalian cells-produced properly glycosylated MCP-1/CCL2, MIP-1 $\alpha$ /CCL3 and ENA-78/CXCL5 can be efficiently citrullinated and successfully used as the standards in modified ELISA assays as well as in bioassays.

**Conclusion:** Glycosylation that is lacking in bacterially-produced proteins but occurs in mammalian cells stabilizes citrullinated chemokines thus protecting them from quickly ongoing partial degradation.

**BioEthics Committee Approval.** All human subject samples were collected after approval by the Institutional Review Board of the Academic Medical Center/University of Amsterdam, Amsterdam, The Netherlands (Protocol MEC 07/079 #10.17.0708) and provision of informed consent by the patients.



## ShRNA-Mediated Knockdown of IL-6 Expression Rescues TNF $\alpha$ -Inhibited Osteogenesis in Mouse Mesenchymal Precursor Cells

Malysheva Kh.<sup>1,2</sup>, de Rooij K.<sup>3</sup>, Löwik C.<sup>3</sup>, Baeten D.<sup>4</sup>, Stoika R.<sup>1</sup>, Korchynskyi O.<sup>1,3,4</sup>

<sup>1</sup>*Institute of Cell Biology, NAS of Ukraine, 14/16, Drahomanov St., Lviv 79005, Ukraine*

<sup>2</sup>*Institute of Animal Biology, NAAS of Ukraine, 38, V. Stus St., Lviv 79034, Ukraine*

<sup>3</sup>*Leiden University Medical Center, 2, Albinusdreef, 2333 ZA Leiden, The Netherlands*

<sup>4</sup>*Academic Medical Center, University of Amsterdam, Amsterdam, The Netherlands*

E-mail: [khrystyna.malysheva@gmail.com](mailto:khrystyna.malysheva@gmail.com).

**Key words:** rheumatoid arthritis, interleukin-6, bone morphogenetic protein, Wnt signaling pathway, mesenchymal precursor cells.

**Introduction.** Rheumatoid arthritis (RA) is a severe autoimmune inflammatory disorder, which etiology remains unknown. It has been demonstrated that interleukin-6 (IL-6) and tumor necrosis factor  $\alpha$  (TNF $\alpha$ ) plays a crucial role in RA pathophysiology. The bone morphogenetic protein (BMP) and Wnt regulatory pathways are key players in signaling mechanisms that induce and support cartilage and bone formation and maintenance. We found that IL-6 inhibits activation of Wnt signaling in primary human synoviocytes, and TNF $\alpha$  and IL-6 cooperatively inhibit the activation of Wnt response.

**Methods.** We performed *in vitro* evaluation of functional contribution of IL-6 and TNF $\alpha$  interaction to inhibition of bone formation by using treatment with recombinant cytokines combined with blocking IL-6 expression by small hairpin RNAs (shRNA) in mouse mesenchymal precursor cells of C2C12 and KS483 lines. These cells were induced to differentiate into osteoblasts by different BMPs.

**Results and Discussion.** We found that treatment of C2C12 cells with TNF $\alpha$  completely inhibited the myoblast differentiation, as well as strongly inhibited BMP-induced osteogenesis. Transient overexpression of shRNA targeting IL-6 mRNA (IL6 shRNA-1) allowed to rescue partially the osteogenic differentiation from negative effect of TNF $\alpha$ , or in case of using IL6 shRNA-2, even to convert TNF $\alpha$  from inhibitor of osteogenesis into its potentiator. Treatment of KS483 cells with hBMP2/7 strongly intensified the late osteoblast differentiation, and overexpression of a combination of six versions of shRNA constructs targeting IL-6 further potentiated osteogenesis compared with a control.

**Conclusion.** IL-6 is an important mediator in inhibition of the osteoblast differentiation by TNF $\alpha$ , and knockdown of IL-6 partially rescues osteogenesis from negative control of inflammation. The anti-osteoblastic effects of IL-6 are most likely mediated by its negative action in Wnt signaling pathway.

**Acknowledgement.** This work was supported by Young Scientist Carrier Support grant from the WUBMRC.

## Evaluation of putative cannabinoid ligands as novel modulators of neuronal function

Senkiv J.V.<sup>1</sup>, Golota S.<sup>2</sup>, Irving J. A.<sup>3</sup>, Lesyk R.B.<sup>2</sup>, Stoika R.S.<sup>1</sup>

1. *Department of Regulation Cell Proliferation and Apoptosis, Institute of Cell Biology, NAS of Ukraine, Lviv, Ukraine*
2. *Department of Pharmacy, Organic and Bioorganic Chemistry, Danylo Halycky Lviv National Medical University, Lviv, Ukraine*
3. *School of Biomedical and Biomolecular Science, University College of Dublin, Dublin, Ireland*  
[Yu.senkiv@gmail.com](mailto:Yu.senkiv@gmail.com)

**Key words (max 5):** G-protein-coupled receptor (GPCR), putative cannabinoid ligands, neuronal function.

**Introduction.** Alzheimer's disease is a complex and progressive neurodegenerative disorder. The available therapy is limited to the symptomatic treatment and its efficacy remains unsatisfactory. Cannabinoid receptors are attracting much attention as potential therapeutic targets. These include the classical cannabinoid receptors CB1 and CB2 as well as novel cannabinoid receptors including GPR55 and GPR18. In particular, GPR55 is sensitive to certain synthetic cannabinoid ligands and, thus, it is important to profile the GPR55 activity of new cannabinoid compounds. Cannabinoid receptors are prominent within the CNS, with the major neuronal sub-types being CB1 and GPR55. A series of cannabinoid-like compounds were synthesized in the Lab of prof. R. Lesyk (Lviv National Medical University) and they have been evaluated for their effects towards primary neurons and recombinant cells expressing CB1 or GPR55.

**Methods.** In this study, we have used a range of functional assays to compare the pharmacological activity of selected cannabinoid ligands, Les-3105, Les-2769, Les-2615, Les-2659, Les-3836, with LPI in neurons and a HEK293 cell line engineered to stably express recombinant human GPR55 and also HEK293 cells transiently transfected with human CB1 receptors.

**Results and Discussion.** We evaluated stimulation of cAMP response element binding protein (CREB) as a reporter for cell activation using Western-blot analysis and immune-cytochemical assay. In addition, we evaluated agonist-induced receptor trafficking as evidence for direct receptor-ligand interactions. We observed striking effects of the studied compounds on pCREB activation in neurons. Current research is directed at evaluating their effects on GPR55 and CB1 activity.

**Conclusion.** We have evaluated a new series of cannabinoid ligands that have clear effects on neuronal functions. The precise molecular targets for these ligands are under current evaluation.

**Acknowledgement.** The Physiology Society of the UK for travel grant awarded to Julia Senkiv.

## Polymeric nanocarrier of temozolomide in glioblastoma treatment

Finiuk N.<sup>1</sup>, Senkiv J.<sup>1</sup>, Molochiy N.<sup>2</sup>, Zaichenko O.<sup>3</sup>, Avdieiev S.<sup>4</sup>, Stoika R.<sup>1</sup>

<sup>1</sup> Department of Regulation of Cell Proliferation and Apoptosis, Institute of Cell Biology, NAS of Ukraine, Lviv, Ukraine

<sup>2</sup> Department of Biochemistry, Ivan Franko National University of Lviv, Lviv, Ukraine

<sup>3</sup> Department of Organic Chemistry, Lviv National Polytechnic University, Lviv, Ukraine

<sup>4</sup> Department of Biosynthesis of Nucleic Acids, Institute of Molecular Biology and Genetics, NAS of Ukraine, Kyiv, Ukraine

E-mail: [nataliyafiniuk@gmail.com](mailto:nataliyafiniuk@gmail.com)

Key words: glioblastoma, temozolomide, apoptosis, polymeric nanocarrier

**Introduction.** Human glioblastoma is the most common adult primary brain tumor with poor prognosis (3% survival). Currently, anti-neoplastic treatment combines chemotherapy (temozolomide, TMZ), radiotherapy, and surgery.

**Aim.** Investigate cytotoxicity of temozolomide immobilized on PEGylated polymeric nanocarrier (TMZ-PC) and study mechanisms of TMZ-induced glioma cell death.

**Methods.** Cytotoxicity assays (MTT and trypan blue), fluorescent microscopy, Western-blot analysis.

**Results and discussion.** TMZ inhibited in a dose-dependent manner the viability of human glioblastoma T98G and rat brain glioma C6 cell lines. The action of TMZ-PC was more pronounced than that of free TMZ. IC<sub>50</sub> of TMZ was 243  $\mu$ M for T98G cells, and immobilization of TMZ by the polymeric nanocarrier reduced IC<sub>50</sub> to 166  $\mu$ M. It was found that TMZ-PC induced apoptosis in malignant glioma cells evaluated by Annexin V-FITC/PI staining. TMZ-PC induced apoptosis through phosphorylation of JNK, STAT3 and Rb. Immobilization of TMZ on the polymeric nanocarrier increased TMZ intercalation into DNA. We found synergistic effect of Doxorubicine and TMZ when targeting human glioblastoma T98G cells.

**Concluding,** modification of TMZ with polymeric nanocarrier leads to increase of cytotoxicity of TMZ and does not change the mechanism of its action. This makes studied complex PC-TMZ perspective for future preclinical investigation.

## **Fluorescent and neuroactive properties of carbon dots synthesized from sulphur-containing carbohydrate precursor**

Tatiana Borisova\*, Mariia Dekaliuk, Natalia Pozdnyakova, Marina Dudarenko, Artem Pastukhov, Anastasia Nazarova, Arsenii Borysov, Alexander P. Demchenko

Dept. Neurochemistry and Lab.of Nanobiotechnology, Palladin Institute of Biochemistry, National Academy of Sciences of Ukraine

**Key words:** carbon dots from thiourea; glutamate; GABA; Na<sup>+</sup>-dependent uptake; brain nerve terminals

**Aims:** Recently, the authors of this study demonstrated neuromodulatory properties of a newly discovered class of carbon fluorescent nanoscale particles, carbon dots (C-dots), synthesized from amino acid  $\beta$ -alanine by microwave heating. C-dots prepared from different types of substances have diverse fluorescent characteristics and surface activity because of exposure of different atoms at their surface, however no data exists whether or not this is accompanied with diversity of their biological activity. The study focused on synthesis, characterization and neuroactivity assessment of C-dots synthesized from sulphur-containing carbohydrate thiourea to provide in nanoparticle structure the atoms of sulfur.

**Methods:** preparative biochemistry, fluorescence and radiolabel assay.

**Results:** Synthesized nanoparticles are highly stable with the size less than 10 nm, and have wide range of emission (420-500 nm) and quantum efficiency more than 30%. Neuroactive properties of C-dots were assessed based on the analysis of their effects on the key characteristics of GABA- and glutamatergic neurotransmission in isolated rat brain nerve terminals (synaptosomes). C-dots attenuated the initial velocity of Na<sup>+</sup>-dependent transporter-mediated uptake of [<sup>3</sup>H]GABA and L-[<sup>14</sup>C]glutamate; increased the ambient level of the neurotransmitters; and changed acidification of synaptic vesicles and the potential of the plasma membrane of nerve terminals.

**Discussion and Conclusion:** Therefore, despite unique fluorescent features of C-dots prepared from different starting carbohydrates, principal neuromodulatory effects of C-dots were almost similar, whereas their strength was different. Different fluorescent and neuromodulatory features combined in C-dots create base for their potential usage for labeling and visualization of key processes in nerve terminals, and also in theranostics.

**Support:** This work was supported by Grant # 6055 of Science and Technology Center in Ukraine (STCU), Cedars Sinai Medical Center's International Research and Innovation in Medicine Program, the Association for Regional Cooperation in the Fields of Health, Science and Technology (RECOOP HST Association).

Experiments were carried out in accordance with the European Guidelines and International Laws and Policies (Directive 86/609/EEC); the protocols were approved by the Animal Care and Use Committee of the Palladin Institute of Biochemistry (Protocol # 2 from 19/09-2014). 20 animals were used in the study.

## Development of New Pharmaceutical Substance and Dosage Form Based on Silver and Copper Nanoparticles for Treatment of Multi-Drug Resistant Tuberculosis

Rieznichenko L.S.<sup>1</sup>, Bilous S.B.<sup>2</sup>, Dybkova S.M.<sup>1</sup>, Goncharenko N.B.<sup>3</sup>, Gruzina T.G.<sup>1</sup>, Ulberg Z.R.<sup>1</sup>

<sup>1</sup>F.D. Ovcharenko Institute of Biocolloidal Chemistry, NAS of Ukraine, Kyiv, Ukraine;

<sup>2</sup>Danylo Halytsky Lviv National Medical University, Lviv, Ukraine

<sup>3</sup>Territorial medical association "Phthisiology", Kyiv, Ukraine

e-mail: [bilous.os@gmail.com](mailto:bilous.os@gmail.com)

**Key words:** metal nanoparticles, tuberculocidal activity, multi-drug resistant *M. tuberculosis*, biosafety, dosage form.

**Introduction:** Multi-drug resistant tuberculosis today is a global public health problem, which becomes an increasing threat for control of tuberculosis spread in the world.

The *aim* of present study is development of new pharmaceutical substance based on metal nanoparticles, estimation *in vitro* of their tuberculocidal activity against multi-drug resistant clinical isolates of *Mycobacterium tuberculosis* and development of liquid dosage form using obtained substance as active pharmaceutical ingredient.

**Materials and methods:** Silver and copper nanoparticles have been synthesized by the method of chemical condensation in water medium. Size, shape and chemical composition of nanoparticles have been characterized using TEM and energy-dispersive X-ray spectroscopy methods. Tuberculocidal activity of the substance has been analyzed *in vitro* by Canetti proportion method using Löwenstein–Jensen medium. 10 resistant to isoniazid and 10 resistant to isoniazid and rifampicin clinical isolates of *M. tuberculosis* have been used for estimation of the substance's tuberculocidal activity. Metal nanoparticles' biosafety level has been estimated according to the parameters of cytotoxicity, genotoxicity and mutagenicity. At development of liquid dosage form methods of information research, literature data analysis and technological methods have been used.

**Results:** 30 nm spherical silver nanoparticles and 20 nm spherical copper nanoparticles have been synthesized by the reduction of their salts in water medium. Mixture of silver and copper nanoparticles has been prepared with concentration of obtained substance 4.0 mg Ag and 32.0 mg Cu per 1 ml. Total inhibition of *M. tuberculosis* growth has been observed under presence of the substance in determination medium in concentration 0.08 mg Ag and 0.64 mg Cu per 1 ml. Biosafety according to the all analyzed parameters has been specified for the obtained mixture as well as for Ag and Cu nanoparticles. The composition and technology of oral liquid dosage form has been developed using obtained substance in different concentration.

**Conclusion:** Pharmaceutical substance based on silver and copper nanoparticles is characterized as biosafe, demonstrates high tuberculocidal properties *in vitro* concerning multi-drug resistant clinical isolates of *M. tuberculosis*. These data indicate its high perspectives in development drugs for treatment of multi-drug resistant tuberculosis.

## Search for antibacterial and antifungal agents among 4-thiazolidinones and related heterocycles. Screening results and perspectives.

S. Golota<sup>1\*</sup>, Ya. Trufin<sup>1</sup>, Ya. Shylych<sup>1</sup>, G. Derkach<sup>2</sup>, V. Zasadko<sup>3</sup>, R. Kutsyk<sup>3</sup>, R. Lesyk<sup>1</sup>.

<sup>1</sup>Department of Pharmaceutical, Organic and Bioorganic Chemistry, Danylo Halytsky Lviv National Medical University, Lviv, Ukraine.

<sup>2</sup>Department of Chemistry of Pharmaceutical Faculty, Ivano - Frankivsk National Medical University, Ivano – Frankivsk, Ukraine

<sup>3</sup>Department of Microbiology, Virology and Immunology, Ivano - Frankivsk National Medical University, Ivano – Frankivsk, Ukraine.

\*Corresponding author's e-mail: golota\_serg@yahoo.com, [roman.lesyk@gmail.com](mailto:roman.lesyk@gmail.com).

**Key words:** 4-thiazolidinones, structure-based drug design, multi-drug resistance, antibacterial and antifungal activity.

**Introduction.** Nowadays search of new antibacterial and antifungal drugs is actual by the multiply drug-resistance (MDR) of strains and emerging pathogens. As one of promising ways to overcome the resistance is the search of new agents among previously not used in treatment classes of chemical compounds. 4-Thiazolidinone derivatives are known as selective inhibitors of UDP-N-Acetylmuramate/l-Alanine Ligase (MurC), MurB inhibitors, peptide deformylase inhibitors etc. and are interesting for development of new antibacterial and antifungal agents.

**Methods.** Nearly 300 4-thiazolidinones and related heterocycles were synthesized using structure-based drug design approach. Traditional pharmacological screening for antibacterial and antifungal activity against methicillin-sensitive (MSSA) and resistance (MRSA) clinical isolates of *Staphylococcus aureus*, *epidermidis*, *haemolyticus*, *hominis*, *Pseudomonas aureginosa*, *Bacillus subtilis* and MDR strains of *Escherichia coli*, *Proteus vulgaris*, *Haffnia alvei*, *Candida albicans* by agar diffusion method was performed. 2D-QSAR modeling was used for hits structure optimization.

**Results and Discussion.** Approximately 25 % among synthesized and tested compounds possess a high level of antibacterial or/and antifungal activity against tested strains. Active compounds demonstrated good effect against MDR strains. 4-Thiazolidinones and related heterocycles antibacterial and antifungal hits structure diversity are presented below:

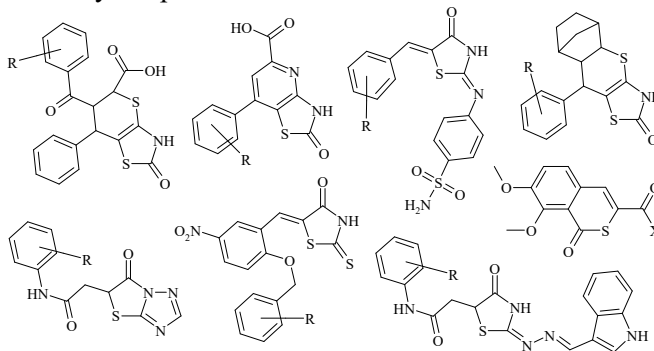

Molecular fragments for focused synthesis and structure optimization were determined using the 2D-QSAR approach.

**Conclusions.** 4-Thiazolidinones and related heterocycles are prospective objects for search of new antibacterial and antifungal agents against Gram-positive, Gram-negative bacteria (including clinical isolates of multidrug resistance strains) and fungi.

Danylo Halytsky Lviv National Medical University **Ethics Committee protocol:** №8, May 05<sup>th</sup> 2015.

## Search for New Antifibrotic Agents among (amino)iminothiazolidinones

Kaminsky D.V.<sup>1</sup>, den Hartog G.J.M.<sup>2</sup>, Bast A.<sup>2</sup>, Lesyk R.B.<sup>1,\*</sup>

<sup>1</sup> Department of Pharmaceutical, Organic and Bioorganic Chemistry, Danylo Halytsky Lviv National Medical University, Pekarska 69, Lviv, 79010, Ukraine;

<sup>2</sup> Department of Pharmacology & Toxicology, Faculty of Health, Medicine and Life Sciences, Maastricht University, PO Box 616, 6200 MD Maastricht, The Netherlands; \*

Corresponding author Roman Lesyk e-mail: [dr\\_r\\_lesyk@org.lviv.net](mailto:dr_r_lesyk@org.lviv.net), [roman.lesyk@gmail.com](mailto:roman.lesyk@gmail.com)

**Keywords:** antifibrotic, anticancer activity, 4-thiazolidinones, ROS.

**Introductio.:** Idiopathic pulmonary fibrosis (IPF) is a chronic progressive lung disease of unknown cause, characterized by exaggerated deposition of extracellular matrix products that typically leads to respiratory failure. Therapeutic options in IPF are limited (e.g. pirfenidone possess proven antifibrotic activity and is most referred agent) and require new effective and non-toxic drugs. 4-Thiazolidinones as privileged structures are attractive tool for design of new drug-like molecules. They can be treated as molecular structures providing baseline affinity for the various biotargets. This opens the possibility to design the thiazilodinones with different pharmacological effects (e.g. anticancer, anti-inflammatory, antifibrotic). The present project is an extension of our ongoing efforts towards search for new thiazolidinones and aimed to discover new antifibrotic and anticancer agents.

**Methods:** Structure-based design, sulforhodamine B (SRB) assay is used for cell density determination, based on the measurement of cellular protein content, superoxide scavenging assay, and real-time (RT) monitoring of cell proliferation with xCelligence system.

**Results and discussion:** The focused thiazolidinone sub-library (2-amino(imino)-5-ene-4-thiazolidinones) was involved into the study. The compounds design was based on the our former findings and pirfenidone similarity. The cytotoxicity of synthesized compounds was assessment by *SRB assay* on HFL-1 cells and cancer cell lines (NCI DTP protocol). The effect of the test compounds on cell proliferation was determined by RT monitoring using the xCelligence system. Synthesized compounds showed a wide range of activities which is linked to structural features. Obtained SAR data will be used for further optimisation. The set of 4-thiazolidinones which displayed potent antifibrotic activity as evidenced by its inhibition of fibroblast viability as well as its effect on fibroblast proliferation was identified. The ROS-depended mode of action of some compounds was shown. Moreover the comparison of antifibrotic and anticancer activity SBR test was carried out.

**Conclusion:** The row of 2-amino(imino)-5-ene-4-thiazolidinones as interesting candidates for in-depth study was identified and Pirfenidone like function from identified compounds can lead to developing a new antifibrotic agents.

Ethical Committee of Danylo Halytsky Lviv National Medical University Animal Care and Use Committee Approval: 18.03.2013, #3

## The role of reactive oxygen species in mechanisms of action of novel recognized anticancer 4-thiazolidinone derivatives (*in vivo* study)

Kobylynska L.I.<sup>1</sup>, Biletska L.P.<sup>1</sup>, Lesyk R.B.<sup>2</sup>, Zimenkovsky B.S.<sup>2</sup>, Stoika R.S.<sup>3</sup>

1– Department of Biochemistry, Danylo Halytsky Lviv National Medical University, Ukraine

2 – Department of Pharmaceutical Chemistry, Danylo Halytsky Lviv National Medical University

3 - Department of Regulation of Cell Proliferation and Apoptosis, Institute of Cell Biology, NAS of Ukraine, Lviv, Ukraine

Corresponding author: [lesya8@gmail.com](mailto:lesya8@gmail.com)

**Key words.** 4-thiazolidinone, reactive oxygen species, free radical oxidation, lipid peroxidation, antioxidant system

**Introduction:** We have synthesized the novel 4-thiazolidinone derivatives of potential anticancer action and their effectiveness was demonstrated while treating human tumor cells *in vitro*. The expression of those effects is strongly dependent on the balance of processes of free radical oxidation (FRO) and antioxidant activity (AOA). The aim of study was to evaluate the role of reactive oxygen species (ROS) measured in blood serum of rats treated with novel 4-thiazolidinone derivatives denoted as 3288, 3882 and 3833, and doxorubicin used as positive control.

**Methods and Materials:** Doxorubicin and compounds 3882, 3288 and 3833 were injected in rat's vein. The levels of superoxide radical, hydrogen peroxide and hydroxyl radical, concentration of nitric oxide, hydrogen sulfide and uric acid were measured in blood serum of rats. The content of malonic dialdehyde (MDA), and activity of superoxide dismutase (SOD), catalase, glutathione peroxidase (GPO), NO-synthase and NO-reductase were also defined as biochemical indicators FRO and AOA processes.

**Results:** AOA induced by 4-thiazolidinone derivatives was significantly lower comparing to the indicators of oxidative stress induced by doxorubicin, taking into account the concentration of all ROS and MDA under study. We also found that activity of antioxidant enzymes (SOD, GPO, NO-synthase and NO-reductase) was more significantly reduced by doxorubicin than by 4-thiazolidinone derivatives, whereas catalase activity was elevated.

**Discussion and Conclusion:** We have demonstrated that increased level of ROS, as well as decreased AOA correlated with level of general toxicity of novel compounds 3288, 3882 and 3833 comparing with doxorubicin. Thus, the search of optimal balance is required between anticancer activity of novel and existing drugs and their effects towards content of ROS and the AOA. Besides, proper modulation of level of induced ROS and AOA might be a useful strategy to decrease the consequences of negative toxic effects of most anticancer drugs in treated organism.

**Acknowledgements.** We thank RECOOP HST Association and CSMC International Research and Innovation in Medicine Program for support. Personal thanks for prof. Kotsyuruba A.V. for help in the experiments.

**BioEthics Committee Approval.** All animal experiments were conducted keeping to European Convention on Protection of Vertebrate Animals (Strasbourg, 1986) and corresponding Law of Ukraine (N944, 14.12.2009). Structure of this study and experimental procedures were approved by Ethical Committee of Lviv National Medical University (N2, 16.02.2015).



## QSAR Studies of 4-thiazolidinone derivatives Showing Antitrypanosomal Activity

Kryshchyshyn A.<sup>1</sup>, Deviniak O.<sup>2</sup>, Grellier P.<sup>3</sup>, Lesyk R.<sup>1\*</sup>

<sup>1</sup> Department of Pharmaceutical, Organic and Bioorganic Chemistry, Danylo Halytsky Lviv National Medical University, Pekarska 69, Lviv, 79010, Ukraine;

<sup>2</sup> Department of pharmaceutical disciplines, Uzhhorod National University, Narodna 1, Uzhhorod, 88000, Ukraine

<sup>3</sup> National Museum of Natural History, CP 52, 57 Rue Cuvier, 75005 Paris, France;

\*e-mail: [dr\\_r\\_lesyk@org.lviv.net](mailto:dr_r_lesyk@org.lviv.net), [roman.lesyk@gmail.com](mailto:roman.lesyk@gmail.com)

**Keywords:** antitrypanosomal activity, 4-thiazolidinones, QSAR.

**Introduction.** Trypanosomiasis belongs to the world's neglected tropical disease. Inadequate funding of research and development programs, national health programs for new antitrypanosomal agents search resulted in that no new drug has been approved during the past 3 decades. Also there are a number of problems associated with the existing drugs, consisting in toxicity, availability and insufficient drugs' effectiveness. Given the fact of the antiproliferative activity of 2-hydrazonothiazolidones, aminoacyl-4-thiazolidinone, 5-ylidenerhodanine-3-carboxylic acids, thiopyranothiazoles established in *in vitro* assays on *T.b.b.* and *T. cruzi*, mentioned classes are the promising direction for antiparasitic agents search. Presented work is the continuation of our study on antitrypanosomal activity of 4-thiazolidinone' diverse derivatives.

**Methods.** Structure-based design, synthesis, antitrypanosomal activity assay, Quantitative structure–activity relationship models (QSAR models) are regression or classification models used.

**Results and discussion.** QSAR Models development was carried out using obtained antitrypanosomal activity data. Evaluation of the activity involved two subspecies: compounds were tested on *T.b.b.* and *T.b.g.* The data from both has been combined together, but the corresponding binary variable was included into predictor matrix aiming to detect possible differences in the activity range. The geometry of compounds has been optimized within MMFF94x force field, and above 1600 molecular descriptors were calculated with E-Dragon and MOPAC6; 774 descriptors were retained in the descriptor matrix. Random Forest (RF) regression, Stochastic gradient boosting, Multivariate adaptive regression splines and Gaussian processes regression were the algorithms used for QSAR modelling. The plots of actual versus predicted values for both RF and Gaussian processes models are quite similar and the results show that both models are valid for screening purposes due to their satisfactory predictive abilities established in the test.

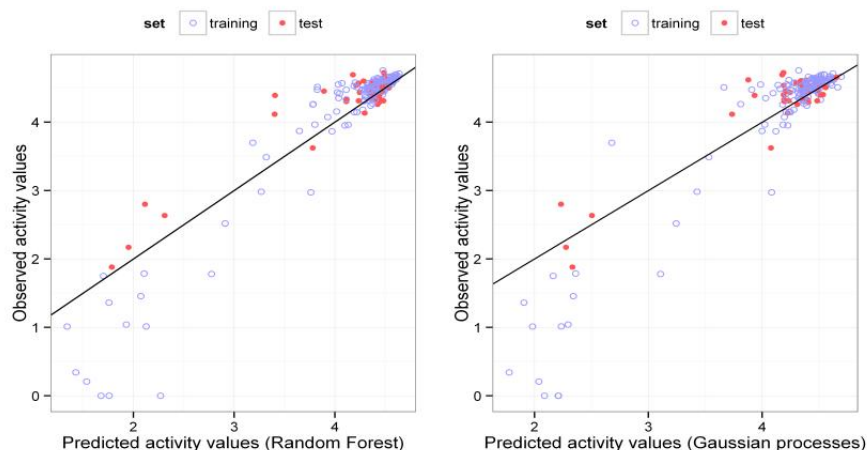

**Conclusion.** QSAR-models developed with RF and Gaussian processes regression algorithms describes antitrypanosomal activity and have good predictive ability. The obtained models are using for current *in silico* screening of new 4-thiazolidinones in search for antitrypanosomal hit-compounds.

**Ethical Committee** of Danylo Halytsky Lviv National Medical University Animal Care and Use Committee Approval: 18.03.2013, #3

## Selected concepts and investigations among thiazolo[4,5-*b*]pyridines as perspective anticancer and anti-inflammatory agents

A. Lozynskiy, B. Zimenkovsky, R. Lesyk

Department of Pharmaceutical, Organic and Bioorganic Chemistry, Danylo Halytsky Lviv National Medical University, Lviv 79010, Ukraine

Corresponding author: Andrii Lozynskiy, loziskij@i.ua

**Key words:** thiazolo[4,5-*b*]pyridines, anticancer agents, anti-inflammatory agents.

**Introduction.** Thiazolo[4,5-*b*]pyridines are have received considerable attention from the medicinal chemists owing to their capacity to mimic a biologically important 4-thiazolidinone fragment in rigid fused system. Therapeutic applications of this template are very broad, and range from cardiostimulant agents (including cAMP PDE III inhibitors) to antimicrobial and anti-inflammatory compounds. High affinity ligands have been obtained also for H<sub>3</sub>-histamine, metabotropic glutamate 5 (mGluR5) and epidermal growth factor receptors. Owing to the high number of positive hits encountered with this heterocycle and its congeners, thiazolo[4,5-*b*]pyridines template certainly deserves the title of “hit-compounds” in medicinal chemistry.

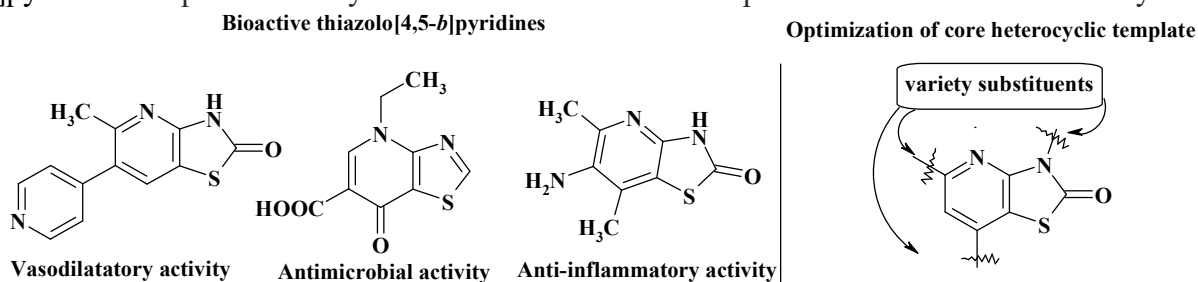

**Methods.** It has been analysed the corresponding research in synthesis and adopted synthetic procedure of obtaining of appropriate biologically active thiazolo[4,5-*b*]pyridines in the reaction [3+3]-cyclocondensation .

**Results and discussion.** All the new thiazolo[4,5-*b*]pyridine derivatives were synthesized from 4-amino-5*H*-thiazol-2-one and various arylidene pyruvic acids or chalcones in the reaction [3+3]-cyclocondensation. The raw of thiazolo[4,5-*b*]pyridine-5-carboxylic acid amides were synthesized by the interaction of corresponding acid chlorides with various amines in anhydrous dioxane. As a result, the library of new thiazolo[4,5-*b*]pyridine-based heterocycles for search of new anticancer and anti-inflammatory agents have been designed and synthesized. The synthesized compounds were selected by National Cancer Institute (NCI) Developmental Therapeutic Program ([www.dtp.nci.nih.gov](http://www.dtp.nci.nih.gov)) for the *in vitro* cell line screening to investigate their anticancer activity and evaluated for their and anti-inflammatory activity on the carrageenan oedema model in rats.

**Conclusion.** The preliminary results allowed to identify the active compounds with promising anticancer and anti-inflammatory activity.

**Acknowledgement:** Thank you for Cedars Sinai Medical Center’s International Research and Innovation Management Program, the Association for Regional Cooperation in the Fields of Health, Science and Technology (RECOOP HST Association) for their support of our organization as participating Cedars-Sinai Medical Center-RECOOP Research Centers (CRRS).

Danylo Halytsky Lviv National Medical University Institutional Animal Care and Use Committee Approval: 18/03/2013 № 3

## Evaluation of Vitamin D Status of Patients with Gynaecological Hyperplastic Syndrome

Shurpyak S.O.

*Lviv National Medical University named after Danylo Halitskyy*

*Department of Obstetrics, Gynaecology and Perinatology*

*Faculty of Postgraduate Education*

*Shurpyak\_serhiy@yahoo.com*

Key words: vitamin D, gynaecological hyperplastic syndrome

**Introduction:** According to the concept gynaecological hyperplastic syndrome, hormonal imbalance triggers undesired proliferation in all organs capable of expressing receptors for estrogen. Violations of system regulatory mechanisms are a major factor in carcinogenesis. One of systematic violations of regulatory processes is the lack of vitamin D. Vitamin D is considered as D-hormone effect on providing genomic and non genomic levels as receptors of vitamin D3 (VDR) are present in more than 30 organs and tissues. Vitamin D controls over 1,000 genes and their corresponding proteins and proved antiproliferative, differentiating, immunomodulatory actions of others.

We study D-status of patients with hyperplastic processes of reproductive organs.

**Methods:** Under the supervision were 47 women aged 20 to 38 years with hyperplastic gynaecological syndrome and 20 women of similar age without extragenital and gynaecological pathology. Verification of diagnosis conducted on the basis of ultrasound, hysteroscopy, endometrial biopsy with subsequent histological analysis. Study of 25 (OH) D serums was performed by immunochemical test (Roche Diagnostics, Switzerland). Assessment D status conducted under recommendations of Central Europe experts.

**Results and discussion:** For majority of examined patients with gynaecological hyperplastic syndrome characteristic was expressed deficiency of vitamin D level of 25 (OH) D was 4 ng/ml to 12 ng/ml (levels in control group of 20 to 30 ng/ml,  $p < 0,001$ ). Determined correlation of severe vitamin D deficiency with clinical course of disease and dysfunction of thyroid gland. Current epidemiological data suggest that low vitamin D plays role in onset and progression of breast cancer and other organs. Antiproliferative effects occur in vitro and in clinical settings, implemented through blockade of G0/G1, induction of apoptosis and direct effects on tumour vasculature.

**Conclusion:** Severity of vitamin D deficiency in patients with gynaecological hyperplastic syndrome can be considered the use of vitamin D as pathogenic variant comprehensive prevention and treatment.

Ethical Committee Danylo Halytsky LNMU: Protocol №4 from 14.04.2014

## **“In silico” approach of assessment stress-related score and its correlation with individual health condition**

<sup>1</sup>Zvir M., <sup>2</sup>Kukhlevskyy Yu., <sup>3</sup>Dorosh O., <sup>2</sup>Masna Z., <sup>3</sup>Dorosh N., <sup>1</sup>Zayachkivska O.

<sup>1</sup>Physiology Department, <sup>2</sup>Topographic Anatomy and Operative Surgery Department, <sup>3</sup>Medical Informatic Department, Lviv National Medical University, Ukraine, e-mail: [ozayachkivska@gmail.com](mailto:ozayachkivska@gmail.com)

**Key words:** life-style risk factors, stress, sitting time, screening, mHealth

**Introduction:** Modern life is characterized by inactivity and excessive interaction with “blue light” devices, which increased stress and sitting time. Despite the major advances in understanding pathogenesis of gastrointestinal illnesses, bone dense lost, muscle degeneration, still research on the factors that influence health and premature ageing has become a priority in medicine. This study is aimed to create new "in silico" diagnostic tool for personal/doctor's efficient convenient control and analyses of health, correction life-style & stress-induced living behavior via mobile health (mHealth) approach.

**Methods:** The cross sectional study using modern “Multi Modular Mathematical” (3M) analysis for BMI, psychophysiological tests, mHealth indentification of sleep, sitting time pattern, evaluation several functional and structural gastro-intestinal (GI) diseases via questionnaires according to Rome III criteria, bone density via radiological investigation was done (n=100) across Lviv's region for development software program, which can work with OS Windows, Linux and Android. To conduct the computer screening, modern platforms such as LimeSurvey, Priska, CATI are used.

**Results:** Screening has shown that Body weight index (BWI) <18.5 was in 21%; normal BWI - 76% in observation group. Prolonged sitting time 65% was similar among young until (30 years) and older (until 60 years) participants. Inability to cope, helplessness, increased psychological pressure, mental tension and too much workload were main self-estimated “stress factors” for young participants, therefore emotional changes in human relationships and interpersonal communication in long-lasting connections, extended family networks, or circles of friends were for older participants. Prevalence of functional & structural GI disorders and osteopenia was indentified also.

**Conclusions:** Innovative 3M & mHealth approach assists for better understanding brain-gut axis among stress-related disorders or whole body data. Integrative data of human parameters will help in detection early risk factors of health disorders and for prevention disease in healthcare and increase personal motivation for healthy lifestyle.

**Lviv National Medical University Ethical Committee Approval:** 15.05.2015, №5

## Physiological aspects of H<sub>2</sub>S-aspirin influence on esophageal and gastric mucosa integrity

Bula N., Pavlovsky Ya, <sup>1</sup>Gavruluk E., Zayachkivska O., <sup>2</sup>Wallace J.L.

Physiology Department, <sup>1</sup>Pathology and Forensic Medicine Department, Lviv National Medical University, Ukraine; <sup>2</sup>Department of Physiology & Pharmacology, University of Calgary, Calgary, Alberta, <sup>3</sup>Department of Pharmacology & Toxicology, University of Toronto, Toronto, Ontario, Canada; e-mail: [ozayachkivska@gmail.com](mailto:ozayachkivska@gmail.com)

**Key words:** H<sub>2</sub>S, aspirin, endothelium, inflammation, cytoprotection

**Introduction:** Aspirin is one of the common drug that acts to protect endothelium but recent discoveries have expanded its role into complex biological processes such as cancerogenesis, tissue repair, aging and age-related disorders. Aspirin-injury of gastro-intestinal barrier has historically been viewed as an irreversible action. Last data has shown that hydrogen sulfide (H<sub>2</sub>S) can act as a critical mediator of gastro-intestinal mucosal protection and repair. It has also been proven that the addition of H<sub>2</sub>S-releasing moiety to the classical NSAID structures results in NSAID-H<sub>2</sub>S with anti-inflammatory activity. The aim of this study was to compare impact of H<sub>2</sub>S-aspirin (ATB-340) vs classical aspirin on esophageal (EM) and gastric mucosa (GM).

**Methods:** Rats were treated with vehicle (control), aspirin, ATB-340 with or without being subjected to water immersion restricted stress (Takagi et al. 1964). Some subgroups of rats were pre-treated with an inhibitor of H<sub>2</sub>S synthesis cystathionine  $\gamma$ -lyase (PAG; 25 mg/kg), cystathionine  $\beta$ -synthase (CHH, 20 mg/kg), and donor H<sub>2</sub>S - NaHS. The damage of the esophageal mucosa (EM) and gastric mucosa (GM) was estimated via microscopic esophagitis and gastritis scores (2011).

**Results:** Treatment with aspirin resulted in the development of severe esophagitis and damage to the esophagogastric junction with disorganization of the muscle plate and irregular submucosal edema and induction of erosive-gastritis. The aspirin-related damage of EM, GM was exacerbated during administration of inhibitors of H<sub>2</sub>S biosynthesis PAG and CHH and attenuated by pre-treatment with NaHS. The results of esophageal and gastric injury after stress induction in rats treated by ATB-340 were lower.

**Conclusions:** The link between inhibition of endogenous H<sub>2</sub>S synthesis and destruction of esophageal and gastric lesions provides a novel experimental data of contribution H<sub>2</sub>S in cytoprotection. H<sub>2</sub>S-aspirin provides esophageal and gastric mucosal defence against acute stress injury. Future ELISA investigations of endothelial cytokines VCAM-1, adrestin, integrin, IL-6 will evaluate.

Lviv National Medical University Ethical Committee Approval: 21.05.2014, №5

## Synthesis of potential antiviral agents among chromeno[4',3':4,5]thiopyrano[2,3-d][1,3]thiazole-5-carboxylates

Nataliya Zelisko, Roman Lesyk

Department of Pharmaceutical, Organic and Bioorganic Chemistry, Danylo Halytsky Lviv National Medical University, Pekarska 69, Lviv, 79010, Ukraine

Corresponding author : Nataliya Zelisko, [NataljaZelisko@gmail.com](mailto:NataljaZelisko@gmail.com)

**Key words:** chromeno[4',3':4,5]thiopyrano[2,3-d][1,3]thiazoles, *hetero*-Diels-Alder reaction, antiviral activity.

**Introduction:** The *hetero*-Diels-Alder cycloaddition is the one of the most powerful methods for the synthesis of polycyclic compounds. It has been used as an excellent synthetic instrument for obtaining thiopyrano[2,3-d][1,3]thiazole derivatives. The mentioned compounds are promising area of research because of their diverse biological activities. Maleic and fumaric acids and their derivatives are good dienophiles and react with a variety of dienes to afford the corresponding cyclohexene system. We decided to evaluate the reaction between 5-(*ortho*-hydroxybenzylidene)-substituted isorhodanines and esters of fumaric or maleic acids as dienophiles.

**Method:** It has been analysed the corresponding research in synthesis and adopted synthetic procedure for obtaining appropriate biologically active chromeno[4',3':4,5]thiopyrano[2,3-d][1,3]thiazoles in *hetero*-Diels-Alder reaction.

**Results and discussions:** Compounds **1a-h** were studied with above-mentioned esters and we have got interesting acylation-*hetero*-Diels-Alder process forming only tetracyclic fused derivatives **2a-h**. Completely unexpected results were obtained for the esters of fumaric acid with the same stereochemistry, as starting with maleic acid. In our opinion, the formation of tetracyclic products **2** with *cis*-configuration of the protons at positions 5 and 5a, 5a and 11b in case of esters of fumaric acid could be explained by the mechanism that includes *retro* Michael addition reaction followed by stereoselective Michael addition cyclization.

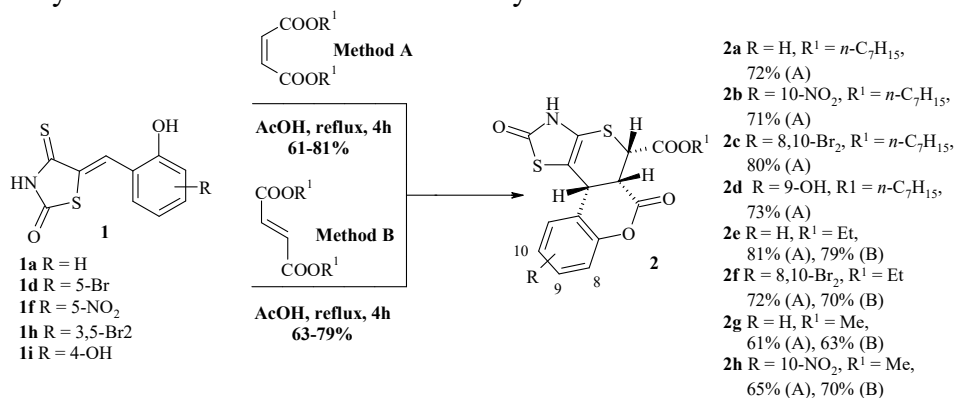

We also investigated antiviral activity for synthesized compounds *in vitro* against *Influenza Virus Type A*. Compounds **2a** and **2f** showed significant activities with a 50% effective concentration (EC<sub>50</sub>) = 0.6 mg/ml, selective index (SI) of >170 and EC<sub>50</sub>=0.31, SI>320 respectively, which are higher than commercial Ribavirin.

**Conclusion:** 5-(2-Hydroxybenzylidene)-4-thioxothiazolidin-2-ones and esters of maleic or fumaric acids undergo tandem acylation-*hetero*-Diels-Alder reaction diastereoselectively providing *rel*-(5*R*,5*aR*,11*bS*)-2,6-dioxo-3,5*a*,6,11*b*-tetrahydro-2*H*,5*H*-chromeno[4',3':4,5]thiopyrano[2,3-d][1,3]thiazole formation regardless of dienophile isomerism. The bioassay results allowed to identify the active compounds with promising antiviral activity.

**Ethical Committee or Institutional Animal Care and Use Committee Approval:** 19/03/2014 № 2

**IKEM Czech Republic not  
identified for CMJ -  
RECOOP CRRC  
3**

## **Biological characteristics of a new glycogen-based hybrid copolymers that could be prospectively used as a drug delivery systems**

Jirátoová M.<sup>1</sup>, Pospíšilová A.<sup>2</sup>, Sekerková A.<sup>1</sup>, Pařízek M.<sup>3</sup>, Jiráček D.<sup>1</sup>, Hrubý M.<sup>2</sup>

1 Laboratory for Atherosclerosis Research, Centre for Experimental Medicine, Institute for Clinical and Experimental Medicine, Prague, Czech Republic

2 Institute of Macromolecular Chemistry, Academy of Sciences of the Czech Republic, Prague, Czech Republic

3 Institute of Physiology, Academy of Sciences of the Czech Republic, Prague, Czech Republic

Corresponding author address: jitm@medicon.cz

**Key words:** glycogen, polymer, drug delivery, EPR, cancer

**Background:** We introduce completely new biodegradable polymer carrier platform based on body's own polysaccharide glycogen. This new polymer carrier platform could overcome some problems of cancer diagnostics and treatment that comes from insufficient selectivity for tumor tissue.

**Methods:** We used five different types of modified glycogen (GG-PMeOx-1-Ds, GG-PMeOx-3-Ds, GG-FITC, GG-PMeOx-1-FITC and GG-Gd DOTA-Dy615). Various techniques of *in vitro* and *in vivo* testing were applied to test potential of this platform, namely confocal microscopy to test cytoplasmic localization of modified glycogen, flow cytometry for assessment of endocytosis of polymer, MTT assay and measurement of *in vivo* fluorescence to address biodistribution and biocompatibility in CD1-Nude mice. HepG2 cell line was used for all *in vitro* tests.

**Results:** Results from confocal microscopy revealed that glycogen-based nanocarriers are present in the cytoplasm but not in the nucleus or in lysosomes. Preferred way of endocytosis for modified glycogen is via caveolae. Drug delivery systems based on glycogen are generally not cytotoxic to the HepG2 cells. *In vivo* testing confirmed biodegradability of the system. The conjugates are also not significantly entrapped into the reticuloendothelial system.

**Discussion:** Glycogen-based nanocarriers are most probably degraded by physiological pathway for glycogen intracellular degradation that would favor their use as a drug delivery systems. Endocytosis via caveolae is in accordance with other studies that were focused on type of endocytosis for dendrimers. Nontoxic character of glycogen-based nanocarriers, with one exception for the highest concentration of GG-Gd DOTA-Dy615, is also quite beneficial for their prospective use as drug delivery systems. Preliminary *in vivo* testing is in accordance with previous study with GG-Gd DOTA-Dy615.

**Conclusions:** Glycogen-based hybrid copolymers offers many beneficial characteristics thus could be prospectively used for cancer diagnostic and therapeutic purposes.

The authors thank for financial support to the Ministry of Health of the Czech Republic, grant #15-25781A

Ethical Committee or Institutional Animal Care and Use Committee Approval: date 30. 8. 2014 and number 42745/2014-OVZ-30.0



## **Glucose addition affects postprandial response of glucagon-like peptide 1 (GLP-1) to a test meal**

K. Zemánková, J. Mrázková, R. Houdková, J. Piřha, J. Kovář

Laboratory for Atherosclerosis Research, Centre for Experimental Medicine, Institute for Clinical and Experimental Medicine

Corresponding author: katerina.zemankova@ikem.cz

**Key words:** postprandial lipemia, triglyceride, glucose, GLP-1, insulin

**Introduction:** Recent data point out that non-fasting TG concentration is associated with CVD closely than fasting TG concentration. However, there is not so much information how particular dietary components of experimental meal affect the response of important signalling molecules during postprandial lipemia. Therefore, we studied the effect of saccharide added to a fat load on the response of insulin, incretin GLP-1 and triglyceride-rich lipoproteins (TRL) to the meal.

**Methods:** Two examinations were carried out in 30 healthy male volunteers (age  $35 \pm 8$ ; BMI  $26.1 \pm 3.2$ ). Men consumed experimental meal containing 75 g of fat (cream) + 25 g glucose (F+G meal) or 75 g of fat (F meal) in control experiment. The blood was taken before meal and 30, 60, 90, 120, 240, 360 and 480 minutes after meal consumption.

**Results:** After F+G meal, glucose concentration rose from  $5.4 \pm 0.4$  to  $6.5 \pm 1.0$  mmol/l in 30 minutes ( $p < 0.001$ ) and insulinemia increased from  $7.3 \pm 3.4$  to  $32 \pm 21.5$  mIU/l ( $p < 0.001$ ). After F meal, insulin increment was smaller (from  $6.9 \pm 2.9$  to  $11.6 \pm 4.7$  mIU/l,  $p < 0.001$ ) and glycemia was not affected. Interestingly, 2hour AUC of both total and active GLP-1 were 19 % and 21 % lower ( $p < 0.001$ ), respectively, when glucose was given with the fat load. No differences in the response of triglyceride (TG) and cholesterol concentration in TRL isolated by ultracentrifugation ( $d < 1.006$  g/l) to F+G and F meals.

**Discussion:** The addition of glucose to a fat load induces physiological response of insulin and, surprisingly, suppresses response of GLP-1 during early postprandial phase compared to a fat load alone. We can only speculate whether such findings could be explained by feedback inhibition of GLP-1 secretion by hyperinsulinemia.

**Conclusion:** The addition of glucose did not affect the magnitude and duration of postprandial triglyceridemia within 8 hours after meal.

Supported by grant No. NT 14027-3/2013 from IGA MH CR.

Date of Ethical Committee or Institutional Animal Care and Use Committee Approval:  
MEK – č.j. 1070/12 G 12-06-37 Praha, 27.6.2012

## **Circadian activity of cholesterol 7 $\alpha$ -hydroxylase is determined by -203A/C polymorphism of *CYP7A1* gene**

Tereza Blahová<sup>1</sup>, Miluše Vlachová<sup>1</sup>, Martin Leníček<sup>2</sup>, Věra Lánská<sup>1</sup>, Libor Vítek<sup>2</sup>, Jan Kovář<sup>1</sup>

*1 Laboratory for Atherosclerosis Research, Centre for Experimental Medicine, Institute for Clinical and Experimental Medicine*

*2 Institute of Medical Biochemistry and Laboratory Diagnostics, Charles University, First Faculty of Medicine, Czech Republic*

Corresponding autor: Tereza Blahová, [tereza.blahova@ikem.cz](mailto:tereza.blahova@ikem.cz)

**Keywords:** cholesterol 7 $\alpha$ -hydroxylase, genetic polymorphism, diurnal variation, bile acid sequestrant, chenodeoxycholic acid

**Introduction;** The -203A/C polymorphism of *CYP7A1* gene encoding cholesterol 7 $\alpha$ -hydroxylase (*CYP7A1*) plays an important role in determination of cholesterolemia responsiveness to the diet. Importantly, the *CYP7A1* activity displays a considerable diurnal variation. Therefore, we analyzed whether -203A/C polymorphism is involved in circadian regulation of *CYP7A1* activity.

**Methods:** The three experiments lasting 15 hours were carried out in 16 healthy male volunteers, 8 homozygous for -203A and 8 homozygous for -203C variant. First of these experiments was carried out after one day treatment with bile acid sequestrant (Questran®), the second after one day treatment with chenodeoxycholic acid (Chenofalk®) and the third one without any treatment (control). The concentration of 7 $\alpha$ -hydroxy-4-cholesten-3-one (C4), a serum marker of *CYP7A1* activity, was measured from 7 AM to 10 PM in 90min intervals. The experiments were carried out in at least three weeks intervals and their order was randomized.

**Results:** The treatment with bile acid sequestrant resulted in fourfold and eightfold increase of *CYP7A1* activity during the day in A and C allele homozygous carriers, respectively. The treatment with chenodeoxycholic acid resulted in a pronounced decrease in *CYP7A1* activity in carriers of both variants. Importantly, in control experiment the homozygous carriers of -203A allele manifested a noticeable peak of an enzyme activity around 1 PM whereas no such peak could be observed in -203C allele carriers.

**Discussion:** Currently, signaling pathway responsible for differences in diurnal variation of *CYP7A1* activity between -203A and -203C alleles homozygous carriers remains to be identified. It is not also clear whether these differences can explain the cholesterolemia hyporesponsiveness to a dietary fat and cholesterol in A allele homozygous carriers.

**Conclusion:** -203A/C polymorphism of *CYP7A1* has a substantial impact on diurnal variation of enzyme activity.

Supported by grant No. NT 13151-4/2012 from IGA MH CR.

Ethical Committee Approval: G 12-06-34, 27. 6. 2012

**None RECOOP CRRC  
Abstracts: Ukraine  
DHLNMU, Lviv**

**Cardiovascular  
5**

## ***H. pylori* in sedentary males is linked to higher heart rate, sympathetic activity and insulin resistance but not inflammation or oxidative stress**

A.Cherkas<sup>1\*</sup>, P.Eckl<sup>2</sup>, F.Gueraud<sup>3</sup>, O.Abrahamovych<sup>1</sup>, V.Serhiyenko<sup>4</sup>, O.Yatskevych<sup>1</sup>, M.Pliatsko<sup>1</sup>, S.Golota<sup>5</sup>

<sup>1</sup>Department of Internal Medicine №1, Danylo Halytskyi Lviv National Medical University, Lviv, Ukraine

<sup>2</sup>Department of Cell Biology, University of Salzburg, Salzburg, Austria

<sup>3</sup>Research Center in Food Toxicology, INRA, INP, UPS, Team 9 "Prevention, Promotion of Carcinogenesis by Food", Toulouse, France

<sup>4</sup>Department of Endocrinology, Danylo Halytskyi Lviv National Medical University, Lviv, Ukraine

<sup>5</sup>Department of Pharmaceutical, Organic and Bioorganic Chemistry, Danylo Halytskyi Lviv National Medical University, Lviv, Ukraine

\*Corresponding authors e-mail: cherkasandriy@yahoo.com

**Key words:** *Helicobacter pylori*, sedentary lifestyle, heart rate, heart rate variability, insulin resistance

**Introduction:** The rate of *Helicobacter pylori* contamination in healthy subjects without any gastrointestinal complaints vary between 10 and 60 percent in different countries. Contamination by this bacterium may be related to some systemic effects including promotion of atherosclerosis and hypertension, thus sedentary lifestyle may potentiate these effects.

**The aim** of the study was to compare anthropometric parameters, body composition, lipid, hormonal and inflammatory profiles, oxidative stress indices and heart rate variability (HRV), in *H.pylori* positive and negative healthy sedentary subjects.

**Methods:** Among 30 randomly recruited male subjects without any significant health problems (age between 20 and 40) enrolled in this cross-sectional study 18 were found to be *H.pylori* negative while 12 were positive (stool antigen test). Subjects underwent routine physical examination, anthropometric parameters and body composition determination. The following biochemical parameters were determined in blood: fasting whole blood glucose, glycated hemoglobin, insulin, C-peptide, cortisol, aldosterone, testosterone, thyroid stimulating hormone, C-reactive protein, interleukins 6 and 10, tumor necrosis factor- $\alpha$ , and the urine level of 1,4-dihydroxynonane mercapturic acid, a water soluble metabolite of 4-hydroxy nonenal. Electrocardiogram in supine position and in orthostatic test was performed for HRV evaluation. T-test for independent samples and nonparametric Mann-Whitney U test (for HRV parameters) were employed for statistical analysis.

**Results and Discussion:** *H.pylori* contamination in healthy sedentary subjects was not associated with any changes in anthropometric parameters, body composition, blood pressure, lipid profile, fasting glucose or glycated hemoglobin levels. *H.pylori*-positive subjects, however, had significantly higher heart rate at rest ( $p=0.009$ ), sympathetic/parasympathetic balance, especially in orthostatic test ( $p=0.029$ ), fasting insulin level ( $p=0.037$ ) and HOMA-index ( $p=0.047$ ). No significant difference was found for inflammatory markers as well as 1,4-dihydroxynonane mercapturic acid.

**Conclusions:** *H.pylori* contamination is linked to significantly higher heart rate, sympathetic activation and increased insulin resistance while inflammatory and oxidative stress markers remain unaffected in healthy sedentary male subjects.

**Acknowledgements (funding).** The work was supported by State Agency of Science, Innovations and Informatization of Ukraine contracts #M512-2011, #M473-2012, OEAD Project UA 03/2011.

**Ethics committee:** Study design and protocol was approved by Ethics Committee of Danylo Halytskyi National Medical University, protocol №5, May 17<sup>th</sup> 2010.

## **Changes of mitochondrial apparatus of cardiomyocytes during experimental streptozotocin-induced diabetes**

Dzhalilova E., Kryvko Y.

Department of Normal Anatomy, Danylo Halytsky Lviv National Medical University  
Pekarska st., 69, Lviv, 79010, Ukraine

Corresponding author: Elvira Dzhalilova – e-mail: [dzhalilovae@gmail.com](mailto:dzhalilovae@gmail.com)

**Keywords:** cor, myocardium, mitochondria, cardiomyocytes.

**Introduction:** In nowadays one of the most significant challenges for the medicine is the prevalence of cardiovascular pathology among the patients with diabetes. In Ukraine the question of the cardiovascular death rate growth in the general population is one of the most burning in Europe.

**Materials and methods:** The male white rats were used in this experiment, the insulin-dependent form of the experimental streptozotocin-induced diabetes was caused by a single 7 mg/100g. The samples were taken on 2, 4, 6, 8 and 10 weeks. The electron microscopy pictures were made and the ImageG v.1.48 software were used for measurements.

**Results:** The study of mitochondrial apparatus in streptozotocin-induced diabetes showed abnormal diffuse character, but varies in severity between areas of myocardial myofibrils, subsarkolem and paranuklear. Some mitochondria, regardless of the default identity, with signs of moderate vacuolization matrix. Devastated mitochondria found in paranuklear space and much less under sarcolemma or between myofibrils. Mitochondria are elongated type (Type 1) are replaced by spherical (Type 2). In the control group, dominate mitochondria are elongated and flat shape (Type 1 and 3). As a result, dramatically changing relationship between mitochondria 1 i 2 types.

**Discussion and conclusion:** In the early stages of the experimental streptozotocin-induced diabetes the symptoms of microcirculation disturbance in myocardium are noticed. Changes of mitochondria diameters and structure, as well as wall thickness, depending on the duration of the experiment were found. Besides, slight diffuse damage of mitochondrial apparatus in all parts of the myocardium by increasing number of mitochondria spherical shape was observed.[1]

The experiment was approved by the University Animal Care and Use Bioethical Committee:  
**Protocol #20, 15May2006**

## **Ionized Calcium and Acid-base Status Imbalance in Coronary Artery Calcification**

O.M. Holtvyan, J.H. Kyyak, H.J. Kyyak

Department of Family Medicine, Danylo Halytsky Lviv National Medical University, Ukraine  
The corresponding author's, e-mail: Olha Holtvyan, [green.la@ukr.net](mailto:green.la@ukr.net)

**Keywords:** ions, calcium, ischemia, metabolic acidosis, Agatston index.

**Introduction:** Ionized calcium (IC) reflects true calcium status of the body in health and disease. The role of calcium in the maintenance of cardiovascular function is complicated and depends on many factors, especially on acid-base status. Early studies demonstrated that calcium was deposited in areas of tissue damage and it was contributed to cellular injury. However, the causes of calcium imbalance during ischemia and hypoxia remain uncertain.

**Methods:** We studied 32 patients with the history of coronary artery disease admitted to the cardiology department. All of them were males, average age 44 years  $\pm$  12 (range 31-78 yr.). All patients underwent coronary artery calcium score (CACS) determination by multi-detector computed tomography (MDCT) and calculated according to Agatston criteria. IC were measured by ion-selective electrode potentiometry (ISEP).

**Results:** According to MDCT the lowest Agatston index in our patients was 83 HU and the highest reached up to 4123 HU. In all our patients we found hypocalcaemia by IC and subcompensated metabolic acidosis. Comparing of MDCT and ISEP, significant relationship between the severity of CACS and IC concentration was found: the higher Agatston index was the lower IC became. So-called hypocalcaemia consumption was revealed.

**Discussion:** There have been several published surveys of plasma calcium ion changes that depending on acid-base status. Result are conflicting. I.M. Aguilera and R.S. Vaughan<sup>1</sup> and many other authors reported that acidosis causes increase IC, whereas alkalosis contributes to its reduction. In our investigation decreasing of ionized calcium was accompanied with subcompensated metabolic acidosis. Similar conclusion was found by S. Jankowski *et al.*<sup>2</sup> They noted association between metabolic acidosis and a significant reduction in IC during abdominal aortic vascular surgery.

**Conclusion:** IC is a good indicator of the calcium balance, especially in acid-base disturbances. In the patients with the history of cardiovascular disease ionized hypocalcaemia is common and it's reflect ischaemia as a result of intracellular influx of calcium. Hypocalcaemia consumption may be an additional sign of coronary artery calcification, which can be proved by MDCT and it is an important predictor of coronary events.

**Ethical Committee Approval:** Protocol number 1 issued 20.01.2015 by the Danylo Halytsky Lviv National Medical University BioEthic Committee

### **References:**

1. I.M. Aguilera, R.S. Vaughan. Calcium and the anaesthetist. *Anaesthesia*, 2000, **55**, 779-790.
2. S. Jankowski, J. Knighton, R. Dunnill, D. Dickson. Changes in ionized calcium concentration and acid-base status during abdominal aortic vascular surgery. *British Journal of Anaesthesia* 1998; **81**: 965-967.

## **HbA<sub>1c</sub> levels above 5.7 % predicts both diabetes and cardiovascular events in patients with coronary artery disease and newly detected hyperglycaemia**

Korolyuk O.Ya.

Lviv Danylo Halytsky National Medical University, the Department of Internal medicine No 2, Lviv, Ukraine

The corresponding author's, e-mail address: [olga\\_korolyuk@ukr.net](mailto:olga_korolyuk@ukr.net)

**Key words:** glycated haemoglobin, coronary artery disease, prognosis

**Introduction** Hyperglycaemia is well established cardiovascular risk factor even during prediabetic state. Recently glycated haemoglobin (HbA<sub>1c</sub>) was added by American Diabetes Association to glycaemic diagnostic criteria of diabetes ( $\geq 6.5\%$ ) and prediabetes (5.7-6.4%). The aim of the study was to compare prognosis in patients with coronary artery disease (CAD) and newly detected hyperglycaemia, depending on HbA<sub>1c</sub> levels.

**Methods:** 116 patients with CAD (median age 63 years) with plasma glucose levels  $\geq 6.1$  mmol/L were included into the study. Baseline oral glucose tolerance test disclosed 24 persons with normal glucose regulation, 23 with impaired fasting glucose, 45 with impaired glucose tolerance, and 24 with diabetes mellitus (DM). HbA<sub>1c</sub> was measured using ion exchange chromatography. Survival was analysed by Kaplan and Meier method; cumulative proportion of survival (CPS) was calculated; groups were compared with  $\chi^2$ - and Gehan's Wilcoxon tests. Median duration of follow-up period was 19 months; hospitalization due to acute cardiovascular complications (ACC) and new onset DM were taken as endpoints.

**Results:** according to the initial HbA<sub>1c</sub> levels patients were divided into 3 groups:  $\leq 5.6\%$  (group 1, n=61), 5.7-6.4% (group 2, n=45),  $\geq 6.5\%$  (group 3, n=10). ACC developed in 75 patients: n=29 with CPS 50.4% in group 1; n=37 with CPS 12.5% in group 2; n=9 with CPS 12.5% in group 3 ( $\chi^2=7.5$ , df = 2, p = 0.023;  $P_{1-2} = 0.008$ ,  $P_{1-3} = 0.021$ ,  $P_{2-3} > 0.05$ ). Among 92 non-diabetics at baseline DM developed in 27 persons: n=9 with CPS 64.1%, n=16 with CPS 43.6%, n=2 with CPS 0 in groups 1, 2, and 3 respectively ( $\chi^2=14.12$ , df = 2, P = 0.0009;  $P_{1-2} = 0.0004$ ,  $P_{1-3} = 0.024$ ,  $P_{2-3} > 0.05$ ).

**Discussion and Conclusion:** the risk of both ACC and DM was significantly increased in patients with HbA<sub>1c</sub> levels  $\geq 5.7\%$ .

**Source(s) of research support in the form of financial support, grants** None

**Acknowledgements:** to the chief of the Department of Internal medicine No 2 professor Olena Radchenko who was a supervisor of my PhD thesis; to all collaborators of the Cardiac Care Unit and the Unit of Cardiology in the Municipal 8<sup>th</sup> Clinical Hospital at the base of which the research was performed

**Ethical Committee or Institutional Animal Care and Use Committee Approval:** approved by the Ethics Committee at Lviv Danylo Halytsky National Medical University, protocol number 3, dated by March 23, 2009

## **Features of rats' miocard and its vascular bed due to long-term (7-14 days) experimental opioid intoxication.**

Pokotylo P., Logash M., Pokotylo V.

Department of Normal Anatomy Danylo Halytsky Lviv National Medical University, Pekarska st., 69, Lviv, 79010, Ukraine

Corresponding author: Petro Pokotylo – e-mail: [anatompetro@gmail.com](mailto:anatompetro@gmail.com)

**Keywords:** rat myocardium, cardiomyocytes, experimental opioid intoxication.

**Introduction:** Drug use prevalence remains stable around the world, according to the 2014 World Drug Report of the United Nations Office on Drugs and Crime (UNODC). Thus, the aim of the study was to investigate the rat atrial cardiac wall on the 7-th and 14-th days of the experimental opioid intoxication.

**Materials and methods:** The male white rats were used in this experiment, animals were divided into 3 groups: the 1-st -animals were injected every day by “Nalbuphin” (nalbuphine hydrochloride), the 2-nd - were injected by 0,9% NaCl, and the 3-rd – intact animals. The samples for histology were taken on 7-th and 14-th days.

**Results:** There are numerous alteration processes in myocardium: myocytolysis, vacuolization of cardiomyocytes, cardiosclerosis, enlargement of vessels and their sludge-syndrome were found. On the 7-th day the changes of right atrium walls cardiomyocytes were observed, in particular: the clotted cytoplasm and the presence of vacuoles. The sludge syndrome with parietal thrombus formation was observed in a lumen of some artery. It is noted a swelling of perivascular and interstitial spaces that penetrated muscle fibers and separates their in further. Besides, there small lymphocytic infiltration of cardiomyocytes and interstitial tissue occurs.

On the 14-th day of experimental opioid intoxication more pronounced alternative changes of myocardium were observed: clotted fragmentation, case-like myocytolysis and more vacuoles. There were signs of capillary plethora, stasis and erythrocytes sludge in the lumen of various size blood vessels within the hemomicrocirculatory bedlinks. Besides, the total dilatation of veins and lymphatic capillaries of myocardial hemomicrocirculatory bedlinks were observed.

**Discussion and conclusion:** In a long-term experimental administration of opioid analgesic “Nalbuphine” the alternative changes of various degrees were observed, with further development of cardiosclerosis and violation of myocardium contractile function.

The experiment was approved by the University Animal Care and Use Bioethical Committee  
*Protocol #2 issued on February 20 2012*



**None RECOOP CRRC  
Abstracts: Ukraine  
DHLNMU, Lviv  
Surgery  
5**

## **The Efficiency of Combined Preventive Method of Pathological Scars Formation**

Melnychuk Uriy

*Danylo Halytsky Lviv National Medical University, Department of Maxillofacial Surgery*

[Jurmelnichuk@rambler.ru](mailto:Jurmelnichuk@rambler.ru)

**Key words:** maxillofacial surgery, pathological scars, shock wave therapy, silicone gel.

**Introduction.** Considering the increase in frequency of surgical interventions at which apply external oral accesses, the prevention of pathological scars formations seems actual and unsolved problem of maxillofacial surgery. Also, in view of current trends towards the use of low invasive interventions, the proposed method of combination of the wave shock therapy and silicone gel can have high scientific and practical value.

**Materials and methods.** The work was based on data reviews of 42 patients who used external oral accesses during surgeries in maxillofacial area. All operated patients were divided into two groups:

- the control – in the postoperative period did not apply any preventive measures;
- the research – patients had shock wave therapy with an interval of 4-5 days, combined with application of silicone gel.

Extracorporeal shock wave therapy sessions were conducted with the swiss device Storz Medical Master Plus MP100. Local anesthesia was not used.

**Results.** The clinical evaluation of postoperative scars was conducted before the preventive manipulations, immediately after their completion and after three months. The best results were obtained with a combination of ESWT treatments and silicone gel. At the control examination was noted the improvement of subjective quality indicators of postoperative scars such as vascularization, strength, malleability, pigmentation, color, texture and itching.

**Conclusion.** The results of this clinical study demonstrate the effectiveness and safety of the combined preventive method of pathological scar formation, its positive impact on subjective quality indicators of postoperative scarring.

Excerpt from the minutes of the meeting №7 Ethics Committee of the Danylo Halytsky Lviv National Medical University from "22" on September 2014

## HEV Lapvison – New Method of Visualization in Laparoscopic Surgery

Ogurtsov O.V., Lukavetsky O.V.

Surgery №1 Department, Danylo Halytsky Lviv National Medical University (Nekrasova Street 4, Lviv, Ukraine 79010, surgery1lnmu@ukr.net)

e-mail: [o.ogurtsov@gmail.com](mailto:o.ogurtsov@gmail.com)

**key words:** laparoscopy, complications, visualization, fluorescence.

**Introduction:** Laparoscopy is one of the best ways to treat surgical pathology. The most common cause of intraoperative complications is deterioration of intraoperative imaging, which leads to damaging of anatomic structures: biliary tree, ureter, blood vessels and other organs. In order to improve intraoperative navigation, contrast radiography and fluorescence are used. Today, usage of fluorescence under ultraviolet light is insufficiently studied

**Methods:** During research we used fluorescein sodium, which was injected intravenously (5 mg/kg). Experiment was run on 10 mature male white rats, age 4-5 months, weight 250 - 330 grams and 3 mature pigs, age 5-6 months . Laparoscope was fixed above the operating field (300 mm length, 10 mm diameter, angle of 0 deg.), connected intraoperative imaging system (HEV LapVison). During experiment on pigs, laparoscopic operation with usage of carboxyperitoneum was done. Real-time continuous video was recorded.

**Result:** After intravenous injection of fluorescein at 16 sec we observed fluorescence of renal parenchymatous tissue. The tissue was green coloured and short grained. Imaging of the ureter started from 20 sec, record clearly showed ureteral peristalsis, movement of fluorescence away from the kidneys. At 90 sec appeared clear visualization of the liver parenchyma due to accumulation and emission of fluorescein. During the experiment, fluorescence intensity of the liver decreased, but emission intensity of the biliary tree remained stable.

**Discussion and Conclusion:** Visualization of fluorescence in HEV light is a new technique that shows efficacy in imaging of liver, kidney, ureter and biliary tree. Fluorescein excretion via bile and urine gives it a high selectivity. HEV LapVison showed good results throughout the research. Due to the results of experiment, we can state that the use of fluorescein and HEV LapVison may be able to improve intraoperative navigation and reduce complications.

Danylo Halytsky Lviv National Medical University **Ethical Committee Approval:** date: 26.05.2014 and number: 5

## **Cartilage and Bone Resorption Markers in Patients with Traumatic Injuries of Temporomandibular Joint**

Kh. Pohranychna, R. Ogonovsky, V. Kaminsky

Danylo Halytsky Lviv National Medical University, Department of Surgical Dentistry and Maxillofacial Surgery

Corresponding author: Khrystyna Pohranychna, e-mail: pohranychna@ukr.net

**Key words:** mandibular condyle fractures, pyridinoline, deoxypyridoline

**Introduction:** Traumatic injuries are an important etiological factor in the development of TMJ disorders. One of the unique characteristics of TMJ is that it contains both types I and II collagens. Pyridinoline (Pyr) and deoxypyridinoline (DPyr) collagen cross-links are known markers of bone and cartilage turnover that are found in human urine. The present study was designed to quantify Pyr and DPyr levels in urine of patients with traumatic injuries of the TMJ resulting from mandibular condylar fractures.

**Materials and methods:** urine samples were obtained from 22 patients with traumatic injuries of the TMJ resulting from mandibular condylar fractures, after appropriate preparation, analyzed by high-liquid chromatography and fluorescence spectroscopy for Pyd and DPyr.

**Results:** the urinary concentration of Pyd and DPyr were significantly higher than in norm - 90-150 nmol/mmol creatinine and 25-40 nmol/mmol creatinine, respectively.

### **Conclusions:**

1. Increased levels of Pyd and DPyr confirm bone destruction and cartilage degradation.
2. The evaluated concentrations of Pyd and DPyr are related to specific pathologic findings in the TMJ during MRI scanning.
3. These findings suggest that the level of Pyd and DPyr in urine may be useful diagnostic indicator for intra-articular pathologic changes during TMJ trauma.

**No Source(s) of research support in the form of financial support, no grants.**

**Acknowledgements** to Chief of Department Maxillofacial Surgery Lviv City Hospital, MD V. I. Kaminsky for collaboration in clinical part.

**Ethical Committee Approval:** Lviv National medical University, №6 from 18.06.2015.

## **"The experience of clinical vascular surgery in the treatment of tumors with invasion of the main vessels of the neck."**

Savchenko A. A.<sup>1</sup>, Kobza I. I.<sup>1</sup>, Terletsky I. R.<sup>2</sup>, Verhola M. R.<sup>2</sup>

Danylo Halytsky Lviv National Medical University, Department of Surgery №2, Lviv, Ukraine<sup>1</sup>  
Lviv Regional Clinical Hospital, Department of Surgery №1, Lviv, Ukraine<sup>2</sup>  
Address: Savchenko A. A., Zaliznichna 7m/33b, Lviv, Ukraine  
e-mail: [arkii@ukr.net](mailto:arkii@ukr.net)

Key words: tumor, hemodectoma, carotid artery.

**Introduction:** Even in the early 21 - century removal of tumors of the neck remains an urgent problem of medicine, taking into account the severe complications and high mortality. In the total cancer incidence neck tumors account for about 5% of all cancer cases. Indicator 5-year survival rate in this group is among the lowest among tumors and is for this patient population ranges from 30 to 75% depending on the tumor type, location, stage of the process and the physical condition of the patient.

**Materials and methods:** The results of the retrospective examination and treatment of 50 patients with tumors of neck vessels, who were hospitalized in the vascular compartment of the Lviv Regional Hospital from 1995 to 2014 on the basis of medical records of patients.

To study the characteristics of clinical course of carotid hemodectom all clinical cases were divided into two groups. The first, a core group includes clinical cases of carotid hemodectom, is 20 patients. Second, the control group was formed from clinical cases of tumor invasion of another oncogenesis currently bunch, here included 30 patients.

**Results:** In both groups, clinical observation was performed a total of 45 operations.

In the study group were performed the following operations: removal of the tumor with vascular wall defect closure - 12, removal of the tumor with ligation of the external carotid artery - 2 (while in one case with ligation of the jugular vein), removal of the tumor with resection of the common carotid artery - 3, removal of the tumor with lymph nodes - 2 (1 case was held intersection and ligation of the vagus nerve).

In the second group performed the following operations: removal of the tumor - 17, removal of the tumor with resection of the facial vein - 1, removal of the tumor with resection of the sternoclavicular muscle - 2, tumor removal with rotary intersection nerve – 1, removal of metastases - 1, resection of metastases with boundary resection of the lung – 1, excision of the tumor with resection of the internal jugular vein - 1, removal of the tumor with resection of the common carotid artery – 1, strumectomy with lymphadenectomy - 1.

**Conclusions:** Clinic Experience shows that surgery is an effective treatment for carotid hemodectom and tumors with invasion into vessels of the neck, providing a low rate of complications, a full recovery or long-term remission.

Approved by the ethical committee of Danylo Halytsky Lviv National Medical University, protocol №2 from 11.02.2015.

## **Skin grafting and negative pressure wound therapy for treating leg ulcer**

Verkhola M.R.<sup>1</sup>, Terletsyki I.R.<sup>1</sup>, Orel Yu.G.<sup>2</sup>, Savchenko A. A.<sup>2</sup>, Vykhtyuk T.I.<sup>2</sup>, Slabyy O.M.<sup>2</sup>

Lviv Regional Clinical Hospital, Department of Surgery №1, Lviv, Ukraine<sup>1</sup>

Danylo Halytsky Lviv National Medical University, Department of Surgery №2, Lviv, Ukraine<sup>2</sup>

Address: Verkhola M.R., Vernygora 21/8, Lviv, Ukraine

e-mail: mverhola@gmail.com

**Key words:** venous ulcer, skin grafting, NPWT

**Introduction.** Treatment of patients with venous ulcers characterized by long duration, complexity and high percentage of relapses. With increasing of disease duration decreases probability of cicatrization of wounds. Very often for wound healing is not enough to use the medicinal methods of treatment and it is necessary to combine them with surgical techniques.

**Methods.** In research are plugged the results of treatment of 74 patients, with venous ulcers the area of which exceeded 50 cm<sup>2</sup>. **Missing Ethical Committee Approval** Patients parted on a few groups depending on the methods of treatment, which was used for them. In the first group are patients, which were conducted with medicinal therapy, elastic compression. In the second group, closing of wound took place by implementation of skin grafting. In majority after implementation of skin grafting to patients was used negative-pressure of wound therapy (NPWT).

**Results.** The results of research shows that in the group of patients, which were treated by the conservative methods of treatment the area of wound diminished on 15±3%. In the group of patients which skin grafting was conducted there were 50 patients, in 39 cases NPWT was used and efficiency of the conducted operation was 95-97%, in one case viability of transplanted skin grafts made near 50%, that probably predefined by concomitant rheumatic pathology. Skin grafting was conducted to 11 patients without the use of NPWT, migration of greater part of transplanted skin grafts are marked in 4 cases, that needed the repeat of skin grafting. In 7 cases the percent of fixed skin grafts made near 85-90%. The terms of stationary treatment were 18±5 days.

**Conclusions.** Research shows that the use of skin grafting reduces the healing time of ulcers in patients with venous ulcers. The use of NPWT increases efficiency of skin grafting, reduces the need of repeated skin graftings in patients.

**None RECOOP CRRC  
Abstracts: Ukraine  
DHLNMU, Lviv  
OBGYN  
2**

## **Comparison of Two Dimensional and Three Dimensional Ultrasonography in Differential Diagnosis of Septate and Bicornuate Uterus**

Veresnyuk, N., Pyrohova, V.

*Department of Obstetrics, Gynecology and Perinatology, Faculty of Postgraduate Education,  
Danylo Halytsky Lviv National Medical University, Ukraine  
e-mail: veresniuk@ukr.net*

**Key words:** Bicornuate uterus, septate uterus, 3D-ultrasonography.

**Introduction:** Traditionally, uterus malformations was diagnosed with invasive method like hysterosalpingography and hysteroscopy. The objective of the present study was to estimate the accuracy of three dimensional ultrasonography in the differential diagnosis of septate and bicornuate uterus compared with two dimensional ultrasonography. Hysteroscopy and laparoscopy confirmation was assigned as the gold standard.

**Methods:** This retrospective study was performed among 28 infertile women aged 24 to 42 years with suspected septate uterus and bicornuate uterus. An inclusion criterion was suspected on uterus septate or bicornuate based on hysterosalpingography or experiencing recurrent miscarriage, preterm labor. The results of 3D and 2D ultrasonographies were compared, while they were confirmed by hysteroscopy and laparoscopy result in detection of septate or bicornuate uterus.

**Results:** All women underwent hysteroscopy with laparoscopic supervision, following 2D and 3D-ultrasonography at the same or subsequent cycle. Congenital anomalies were correctly identified in 26 of 28 (92.3%) cases by 3D-ultrasonography and only in 12 of 28 (42.8%) cases by 2D-ultrasonography. No adverse effects were reported after sonography.

**Discussion and Conclusion:** Three dimensional ultrasonography is an accurate, quick and noninvasive technique for detecting and diagnosing uterine anomalies, which can serve as the gold standard in the assessment of congenital uterine malformations. However, 2D sonography is a good screening tool for the detection of uterine anomalies.

Danylo Halytsky Lviv National Medical University Ethical Committee Approval: 28.08.14, №1.



## The Effectiveness of Hysteroscopic Metroplasty in Patients with Septate Uterus

Veresnyuk, N., Pyrohova, V.

*Department of Obstetrics, Gynecology and Perinatology, Faculty of Postgraduate Education,  
Danylo Halytsky Lviv National Medical University, Ukraine  
e-mail: veresniuk@ukr.net*

**Key words:** Hysteroscopy, septate uterus, metroplasty.

**Introduction:** Septate uterus is one of the most common forms of congenital uterine malformation. It increases the incidence of miscarriage and infertility. Hysteroscopic metroplasty is the gold standart for assessing uterine septa. The aim of this study was to evaluate the reproductive outcomes after hysteroscopic resection of the uterine septum.

**Methods:** 36 women with septate uterus were enrolled in the study. Diagnosis was established by three-dimensional ultrasonography, hysterosalpingography, magnetic resonance imaging and hysteroscopy. In all cases we performed hysteroscopic metroplasty and then we analyzed the reproductive efficiency of it.

**Results:** We treated a group of patients between 23 and 42 years old. The mean age of the women was  $31.3 \pm 5.1$  years. 12 (33.3%) patients consulted for primary infertility. The mean duration of infertility was  $3.8 \pm 1.6$  years. Recurrent miscarriage had 22 (61.1%) and 2 (5.6%) of all patients were asymptomatics. Uterine metroplasty was performed using an operative hysteroscope under general anaesthesia and laparoscopic supervision. All procedures were performed with monopolar electrosurgery. No intraoperative or postoperative complications occurred. Mean follow-up time was  $29.6 \pm 7.2$  months. All of the patients tried to become pregnant. The overall pregnancy rate after hysteroscopic metroplasty was 52.8% (19/36): 17 patients (47.2%) did not achieve pregnancy, 16 (44.4%) achieved spontaneous pregnancy and 3 (8.3%) got pregnant by in vitro fertilization. From all pregnant patients 4 (21.1%) had miscarriage, 13 (68.4%) ended in term deliveries, 2 (10.5%) ended in preterm deliveries before 37 weeks gestation. Termination was by caesarean section in 26.3%.

**Discussion and Conclusion:** Hysteroscopic septum resection is an effective and safe approach for the removal of septum. Hysteroscopic metroplasty in women with septate uterus significantly improves the reproductive outcomes and the live birth rates.

Danylo Halytsky Lviv National Medical University Ethical Committee Approval: 28.08.14, №1.

**None RECOOP CRRC  
Abstracts: Ukraine  
DHLNMU, Lviv  
Clinical/ Miscellaneous  
7**

## **Assosiation of extraesophageal displays of gastroesophageal reflux disease with alkaline reflux in children**

prof. Gnateyko O.Z., prof. Lychkovska O.L., ass.prof. Dats-Opoka M.I.

Danylo Halytsky Lviv National Medical University

Department of pedepediatrics of pediatrics and medical genetics

Marta Dats-Opoka, martadats@gmail.com

**Keywords:** gastroesophageal reflux disease (GERD), children, duodenogastric reflux

**Introduction:** Duodenogastric reflux (DGR) in children often has atypic clinical displays, which complicates the diagnosis and leads to the delay of adequate treatment.

**Aim:** to explore special clinical features of gastroesophageal reflux disease (GERD) with alkaline and acidic reflux.

**Materials and Methods:** observation of 75 children, between 6-16 years of age diagnosed with non-erosive reflux. The compound catalog of complaints, anamnesis data, clinical, endoscopic and ph - metric evaluation were analysed. The anxiety level of these children was studied with the use of CMAS tests.

**Results:** 35 (46,7%) of examined children were diagnosed with alkaline reflux and 40 (53,3%) with acidic reflux accordingly. Typical GERD symptoms such as - (heartburn, odynophagia) were present with equal frequency in both groups. Children without DGR were diagnosed with epigastric abdominal pain syndrom more frequently ( 62,5 %  $\pm$  9,3% against 42,9 %  $\pm$  6,6%,  $p < 0,05$ ). In the group of children with alkaline reflux - extraesophageal displays of the reflux disease were present more frequently (62,9%  $\pm$  6,5% against 32,5%  $\pm$  9,0%,  $p < 0,05$ ). Displays of childhood anxiety and vegetative dysfunction were more frequently noted in the same group as well.

**Conclusion:** children with alkaline reflux are more likely to have extraesophageal dysplays of GERD. This could be the reason of long-term ineffective treatment by the doctors of other specialties (pulmonologists, otolaryngologists).

Ethical Committee Approval December 15, 2014 № 10.

## **Diagnostic criteria of necrotizing fasciitis in patients with diabetes mellitus**

Yu.O. Fuss<sup>1</sup>, A.O. Voloboyeva<sup>2</sup>.

Department of Physical Training and Sport Medicine<sup>1</sup>, Department of Anesthesiology and Intensive Care<sup>2</sup>

Danylo Halytsky Lviv National Medical University<sup>1</sup>, R8-MKML<sup>2</sup>

Corresponding author: Yulia O. Fuss, e-mail: [fuss\\_julia@mail.ru](mailto:fuss_julia@mail.ru)

**Key words:** “purulent surgical infection”, “necrotizing fasciitis”, “diabetes mellitus”, “LRINEC scale”.

**Introduction:** Infectious diseases remain one of the most common causes of morbidity and mortality in patients with diabetes mellitus (DM). Necrotizing infections of soft tissues are severe, rapidly progressing infections, accompanied by expressed intoxication, often damage to fascia, muscles or fatty cells, with the course without purulent exudate.

**Methods:** 32 patients with DM were clinically examined. Among patients 12 (37.5%) were men and 20 – women (62.5%). Patients were chosen for investigation based on the factors, which promote appearance of necrotizing fasciitis: 18 patients were over 50 years old, 10 patients consumed alcohol, atherosclerotic damage to lower extremities was detected in 4 patients.

**Results:** In 2004 a group of patients from Singapore suggested a scale of indices of laboratory risk for necrotizing fasciitis (LRINEC) for early differential diagnostics of NF. C-reactive protein, leukocytes, hemoglobin, blood serum sodium, serum creatinine are evaluated according to this scale. It has been marked that in the sum of points below 5 the risk for NF appearance is low, 6-7 points – medium, more than 8 – high risk.

We obtained the following results according to LRINEC scale: 12 patients had total points below 5, 13 – had 7 points, and 7 patients had over 8 points. Thus, every third examined patient with DM has a risk for development of NF infection.

**Discussion:** Having analyzed the results we proved that patients with DM are susceptible to necrotic fasciitis development.

**Conclusion:** 1. Difficulty of early diagnostics, low level of information available for practical surgeons, absence of marker symptoms and rapidly progressing and irreversible modifications are the causes of untimely diagnostics in patients with DM, and likelihood of necrotic infections of soft tissues. 2. Use of LRINEC scale in patients with DM is necessary for prevention of necrotic infections of soft tissues.

Danylo Halytsky Lviv National Medical University **Ethical Committee Approval:** №8 from 22.10.2012.

Funding. The study was financially supported by the Department of burn injury, R8-MKML.

Acknowledgements. We thank B.S. Zimenkovskyj, rector of Danylo Halytsky Lviv National Medical University<sup>1</sup>, V.R. Obaranec, Chief physician of R8-MKML<sup>2</sup>.

## Gender Aspects of Human Molars' Enamel

P.A. Gasiuk, A.B. Vorobets, T.I. Dzetsiukh

SHEI «I.YA.HORBACHEVSKY TERNOPIL STATE MEDICAL UNIVERSITY»

Department of Prosthetic Dentistry

e-mail: p.gasyuk@mail.ru

Keywords: enamel, fossa, additional fissures.

**Introduction:** Additional fissures are arranged on the chewing surfaces of the molars, is carried trophics of enamel surface layers by contact with salivary fluid enriched with calcium ions. The content of the last depends on many factors including hormonal factors. Based on this provision, we conducted microscopic examination of the additional fissure structure separately for men and women.

**Methods:** The research was conducted on molars separately for men and women using histochemical staining Iodine acid Schiff-Alcian blue, thionine, silver plating and investigate in epymicroscope.

**Results:** It was found that the additional fissures are located near the main fissures or fossa around. It was found that men mostly found ductal-tubular and less ductal-alveolar type of structure of the additional fissures. At duct- tubular type structure of the additional fissures ducts have a tubular structure and a lumen of varying width, which contains grains of lime in white. From duct tubular processes depart perpendicularly or obliquely. At ductal-alveolar type of additional fissures next to the canals and tubules present structure of granular-filamentous type. According to the results of histochemical research of additional fissures in women found that they have the alveolar type of structure and are located near contours of the main fissures. In some cases they are located separately. Thus, unlike men ductal part in them is almost absent. Tubular processes differ from the duct by thinner wall.

**Discussion and conclusion:** Men have additional fissures located in the thickness of the cuticle, reaching its the inner layer of the cuticle. They are surrounded by fossa or fissures parallel to accompany the progress in the form of ductal-tubular, less ductal-alveolar structures. Unlike men women mostly found alveolar or tubulo-alveolar type of fissures. They sometimes cross the contours of the main fissures, but most are located on their own.

Missing Ethical Committee Approval

## **Prevalence of caries of permanent teeth in overweight children.**

Kostura V.L., Bezvushko E.V.

Pediatric dentistry department, Danylo Halytskyi Lviv National Medical University,  
Pekarska str.69, Lviv,  
[torialmax@yahoo.co.uk](mailto:torialmax@yahoo.co.uk)

**Key words:** Overweight, children, dental caries.

**Introduction:** The growth of chronic somatic illness is a serious problem for dental health. WHO focuses in prevalence of excess weight among children. Annually almost 1,000 new cases of obesity are fixed in Ukraine among the children under 14 years old. Therefore it is believed that overweight and obesity are important risk factors for children's health, including for dental one.

**Methods:** We conducted the comprehensive dental examination of 176 overweight children aged 7-16 years. Among them there were 86 boys and 90 girls. A survey of children was carried out as recommended by WHO. The level of caries in child population was assessed based on the definition of such indicators as prevalence (%) and intensity (DMF index). Body mass index was calculated.

**Results:** Analysis of the data showed that the average intensity of caries in overweight boys is  $5.2 \pm 0.47$  tooth and in girls  $5.4 \pm 0.44$  tooth respectively, that is significantly higher than the average value in the comparison group of children (DMF =  $3.4 \pm 0.23$  tooth,  $p < 0.05$ ) and it corresponds to the high level of intensity according to WHO recommendations. The significant difference in the prevalence of dental caries between boys and girls is observed in all age groups.

**Discussion and conclusions:** Interestingly, intensity of caries in 7-10 years old boys is higher (average DMF =  $3.5 \pm 0.23$  tooth) in relation to girls (average DMF =  $2.5 \pm 0.25$  tooth,  $p < 0.05$ ). In the age period from 11 to 15 years caries intensity in boys is lower ( average DMF =  $6.5 \pm 0.5$  tooth) in relation to girls (average DMF =  $7.1 \pm 0.54$  tooth,  $p > 0.05$ ).

Caries prevalence in overweight children is 85.2%, while the intensity makes  $5.3 \pm 0.46$  tooth, that is significantly higher in relation to the comparative data ( $p < 0.05$ ).

**Source of research** support is private, paid by myself. No grants.

**Acknowledgements:** to my scientific adviser Bezvushko E.V. and children of Lviv schools №4, 29, 53.

Danylo Halytskyi Lviv National Medical University **Ethical Committee approval** -20.01.2015, protocol №1.

## **Pain Syndrome in Patients with Acute Pancreatitis: Pain Recognition Quality Research.**

**V. Kunovsky<sup>1</sup>, A. Kvit<sup>2</sup>**

<sup>1</sup> Lviv National Medical University, <sup>2</sup> Endoscopy surgery department, Lviv, Ukraine

**e-mail:** [adrian\\_kvity@yahoo.pl](mailto:adrian_kvity@yahoo.pl)

**Key words:** pain syndrome, pain scales, acute pancreatitis.

**INTRODUCTION:** Treatment of patients with acute pancreatitis (AP) is still an urgent problem, taking into consideration that this disease differs from the others with intensive pain, which is hard to recognize and treat.

**METHODS:** Our prospective research, which provides a comparative valuation of the pain syndrome (PS) expression in patients with AP using two PS scales: Wong-Baker Faces Pain Rating Scale (FPRS) and The Numeric Pain Rating Scale (NPRS), correlating the both scales results. was conducted in the city pancreatic centre on the basis of Lviv City Emergency Hospital. Interrogation of 31 patient with AP was statistically analyzed, namely at the moment of patients' admission and on the second day of the treatment, using FPRS vs. NPRS.

### **Missing Ethical Committee Approval**

**RESULTS:** On the basis of conducted interrogation the following results were gained: according to the FPRS, at the moment of hospitalization, PS in 23 patients (75%) was rated 8 p.; in 4 patients (13%) - 10 p.; in 3 (9%) - 6 p., in 1 case (3%) patient valued his pain 4 p. On the second day of treatment the PS expression level 16 questioned (52%) affirmed their pain to be on the level of 6 p.; in 8 (25%) – 4 p.; in 5 (16%) – 8 p. and in 2 (7%) we observed 2 p. PS.

According to the NPRS at the moment of the patients' admission PS in 27 patients (87%) was valued 7-10 p., in 4 (13%) – 4-6 p. On the second day of the treatment the PS in 19 questioned (62%) was 4-6 p. high; in 9 patients (29%) pain remained on the level 7-10 p., and in 3 cases we observed 1-3 p. high PS.

**CONCLUSION:** As a result we can affirm, that according to both scales data (FPRS vs. NPRS), the reliable ( $p < 0,05$ ) criterions for PS valuation in patients with AP were gained. The data precision ranged from 1 to 2 points, which is not statistically significant. However the FPRS is supposed to be more rational, as it allows to characterize the PS expression level with 2-points interval, which is more informative and reliable index especially on the second and third day of treatment.

## **Echocardiographic parameters in helicobacter-positive and negative patients**

Strilchuk L.M., Department of Therapy № 1 and Medical Diagnostics, Danylo Halytsky National Medical University, Lviv, Ukraine

Larysa Strilchuk [larysa.stril4uk@ukr.net](mailto:larysa.stril4uk@ukr.net)

**Keywords:** helicobacter pylori, left ventricle, dilatation.

**Introduction:** Many scientific investigations concentrate on proving the etiological role of Helicobacter pylori (HP) in cardiovascular diseases, but results are controversial. Z.Azarkar et al. state connection between HP-infection and myocardial infarction, whereas A. Ikeda et al. did not find any bonds. Despite significant amount of investigations, direct connection of HP-infection with echocardiographic parameters was not revealed, that's why it became the aim of our investigation.

**Methods:** We held a retrospective analysis of medical documentation of 110 patients in Rivne Regional Clinical Treatment and Diagnostics Centre named after V.Polishchuk (Ukraine). Investigation included patients aged 18 – 83 years. All patients underwent general blood analysis, urinalysis, biochemical blood analysis, ECG, EchoCG and fibrogastroscopy with urease test. Analysis of results was held with the help of Statistica 6,0 using Mann-Whitney criteria. Data was considered significant if  $p < 0,05$ .

**Results:** According to urease test, patients were divided in two groups: helicobacter-positive (42 patients) and HP-negative (68 patients). Age of patients in groups was comparable: 41,5[32,0;57,0] years and 50,5[31,5;58,0] years. Groups also did not differ in arterial pressure (AP) and body mass index (BMI). Medians of AP and BMI of both groups were in limits of normal AP and overweight. HP-positive patients were characterized by significantly bigger end-systolic (ESV) and end-diastolic (EDV) volumes of LV on the background of smaller thickness of LV walls (posterior wall, interventricular septum, medium relative wall thickness), which can be the sign of left ventricle dilatation.

**Discussion:** As our groups did not differ in age and AP, revealed difference can testify about HP-infection influence on left ventricle remodeling.

**Conclusions:** Changes in EchoCG parameters of HP-positive patients can be the sign of LV dilatation due to helicobacter infection.

No research support or grants were received.

Danylo Halytsky National Medical University Ethical Committee Approval 24.09.15, № 8.



## Self-reported questionnaire for patients with suspected neuropathies in outpatient settings

Yavorska N. P.<sup>1</sup>, Smilevska V.V.<sup>2</sup>

<sup>1</sup>Danylo Halytsky Lviv National Medical University, Pekarska 69, Lviv, 79010, Ukraine;

<sup>2</sup>Private clinic "Echocor", Ugorska 15, Lviv, 79034, Ukraine

e-mails: [yavorskanataliya@gmail.com](mailto:yavorskanataliya@gmail.com)<sup>1</sup>, lera-chudo@ya.ru<sup>2</sup>

**Key words:** neuropathies, questionnaire, outpatient

**Introduction:** Neuropathies are common neurological diseases. Many patients with neuropathies come to out-patient department earlier and wait for a doctor. On the other hand, doctors often have limited amount of time for examination of the patients. The purpose of our work was to develop and evaluate a questionnaire that contains standard questions for such patients and can shorten time of neurologist consultation and simplify history taking.

**Methods:** A questionnaire was administered to collect information about demographic characteristics, duration of illness, symptoms (including pain, with Visual Analog Scale), comorbidities, current and previous medications, recent tests and assessments, and habits. The questionnaire consisted of 26 questions. The questionnaire had also a smaller column, where neurologists could make notes. In total 40 patients (15 women and 25 men, aged 40,2±15,7) completed the questionnaire in a private outpatient clinic. All the patients were referred by physicians who suspected neuropathies in these patients.

**Results:** The completion of the questionnaire took 653±234 sec and the average number of answered questions was 20 (78%). The patients more often (87,7%) answered the questions that required checking the box. The patients reported difficulties during answering questions "Line of Work" (12 patients - 30%) and "Nature of Occupation" (13 patients - 32,5%). The most difficult question for patients was the question "When did you feel healthy last time" (for 16 patients - 40%). The items about medication and investigations were completed by 24 patients (60%) and 30 (75%) patients, respectively. The most common underlined symptoms were numbness (23 patients - 57,5 %) and pain (18 (45%) patients). Nine (22,5%) patients wrote additional signs in blank spaces. Most of the patients (90%) considered this questionnaire as simple.

**Discussion and Conclusion:** This questionnaire is a simple and brief tool but it is required further development prior to application in the clinical practice.

The study was approved by Ethical Committee at Lviv National Medical University (Protocol No.4 dated 20 April, 2015).

**None RECOOP CRRC  
Abstracts: Ukraine  
DHLNMU, Lviv  
Pharmacology/Drug  
Development  
8**

## Study of rheological characteristics of eye ointment

Kukuruza L.V.

Department of Pharmaceutical Chemistry, Danylo Halytsky Lviv National Medical University, 69 Pekarska Str., Lviv, 79010, Ukraine

[kukuruzalesya@ukr.net](mailto:kukuruzalesya@ukr.net)

**Key words:** eye ointment, flurenizide, rheology

**Introduction.** Structural-mechanical (rheological) characteristics of soft medications influence the processes of active substance release from ointment as well as application characteristics – rubbing, adhesion and extrusion. To investigate rheological properties of elaborated flurenizide eye ointment.

**Methods.** The investigation was performed on rheometer Rheolab (Austria).

**Results and discussions.** According to results of investigation flurenizide eye ointment is a pseudoplastic system, has thixotropic properties. Investigated ointment requires certain effort on extrusion, however, this consistency is traditional for eye ointments and is caused by small amount of medication form, which is necessary for application to eye conjunctiva.

**Conclusions:** Rheological properties of the elaborated eye ointment on the basis of flurenizide characterize it as a thixotropic system, which meets the requirements for eye medications. 1% flurenizide ointment is perspective for implementation into domestic production.

## **Pharmacoeconomical and Pharmaco-epidemiological Features of Pharmacotherapy for Patients with Arterial Hypertension**

Zimenkovsky A.B., Zayats M.M., Boretska O.B., Nastyukha Yu.S., Lopatynska O.I.  
*Danylo Halytsky Lviv National Medical University, Lviv, Ukraine*  
*Department of Clinical Pharmacy, Pharmacotherapy and Medical Standardization,*  
The corresponding author's Zayats M.M., [zayatsmarta@gmail.com](mailto:zayatsmarta@gmail.com)

**Keywords:** clinical and economic analysis, hypertension, cost.

**Introduction:** According to evidence-based medicine data, effective health care (mainly – pharmacotherapy (PhT)) is the undisputed factor for improving the quality and duration of life for patients. Therefore, special attention should be paid to quality of PhT and economic consequences.

**Methods:** Bibliographic, analytical, clinico-economic (*ABC/VN, analysis of drugs consumption ATC/DDD, DU90%*) have been used in investigation. Objects: 200 Protocols Drugs Order Forms for the patients with arterial hypertension (AH) (4 health care institution in Lviv (Ukraine)).

**The aim of the research** was creation of pharmaceutical care messages based on the results of clinico-economic studies.

**Results:** The results of DU90% analysis showed that 90% of consumed DDDs accounted for 36 drugs. The highest values of consumption were detected for enalapril, betahistine, acetylsalicylic acid in low doses, valsartan, amlodipine, thioctic acid. Whereas betahistine and thioctic acid are not basic medicines for AH PhT.

For details assessment of rationality costs for PhT, the ABC analysis and formal VN-analysis was carried out and based on their results the projection matrix was modeled.

In accordance to the obtained results, the most costly group A are formed from Vital and Non-essential medicines in the equal proportion (50% of group V vs 50% of group N), though the amount of Non-essential drugs in this group should be minimal. At the same time, 66% of Vital medicines belong to group C. It is mean, that in the cases of studied patients the rationality of PhT from the standpoint of pharmacoeconomics, in our opinion, needs revision, and the group AN – professional clinical and pharmaceutical assessment for following formation of pharmaceutical care messages concerning inefficiency spent resources.

**Conclusion:** Results confirm the necessity of a clinical pharmacist activity in in-patient health care institutions, in particular for clinical and economic analysis, that allow to identify systemic wasteful procurement regarding PhT.

The investigation was conducted as a part of project «Health first. Medical Universities of Poland and Ukraine partnership for improving health care in the Polish-Ukrainian border area» (project ref. number IPBU.03.01.00-06-369/11-00), which funded by the European Union within the Poland-Belarus-Ukraine cross-border cooperation programme for 2007-2013.

The authors declare that there are no conflicts of interest.

The investigation was conducted in accordance with the protocol of Ethical Committee for Institutional Animal Care and Use Committee, approved 20.04.2015 and N 4.

## Study of drug-related problems associated with use of statins in Ukraine

Gorodnycha O.Yu., Lopatynska O.I., Ryvak T.B., Koval A.Ya., Zimenkovsky A.B.

Department of Clinical pharmacy, Pharmacotherapy and Medical Standardization  
Danylo Halytsky Lviv National Medical University, Ukraine

Corresponding author: Oksana Yu. Gorodnycha, e-mail: gor.oxana.27@gmail.com

**Key words:** statins, drug-related problems, quality and safety of pharmacotherapy

**Introduction:** Statins (HMG-CoA reductase inhibitors) are widely used in medicine for reducing serum levels of low-density lipoprotein cholesterol and, consequence, for cardiovascular diseases pharmacotherapy. The aim of our study was to determine the types and frequency of drug-related problems (DRPs) associated with statins intake.

**Methods:** The retrospective analysis of medical records was carried out through the identification of DRPs in accordance with PCNE-DRPs classification v5.01 adapted to Ukrainian healthcare system.

**Results:** The study included 21 medical records of patients admitted to the Cardiology department of inpatient hospital in Lviv, Ukraine. A total number of identified DRPs was 479 DRPs (an average of  $22.8 \pm 8.5$  DRPs per patient). The prevalent DRPs (70.3%) included potential drug-drug interactions, 7.9% – contraindicated prescription, 5.0% – no clear indication for drug administration, 4.4% – co-administration of medicines belonging to the same pharmacological group, 4.0% – incorrect route of drug administration, 2.7% – exceeding dosage and, on the contrary, insufficient dosage (1.7%) of drugs. Also we detected 4.0% technical DRPs associated with inadequate completing medical records (no dosage regimen, drug form and/or dissolvent). It was established that 4.8% (95% CI: 3.1-7.1) DRPs associated with use of statins. These include 3 groups of DRPs: 1) potential drug-drug interactions between statins and calcium channel blockers, cardiac glycosides, antiarrhythmic drugs, and aluminium-containing antacids (n=9); 2) overdose in elderly patients and patients with liver dysfunction (n=7); 3) cases of contraindicated use (n=7).

**Discussion and conclusion:** The most of DRPs associated with use of statins at Cardiology department are significant and predictable. Identified DRPs reduce quality and safety of pharmacotherapy because the risk of adverse events such as rhabdomyolysis, arrhythmias and other complications increases. Thus, prescription of statins should be specially focused on potential drug-drug interactions, dosing regimen and comorbidity.

Danylo Halytsky Lviv National Medical University Ethical Committee Approval: Minutes No 4, 20 April 2015.

## Identification of drug-related problems in prescriptions to patients with cases of hospitalized migraine headache

Kostyana K.V., Ryvak T.B., Zimenkovsky A.B.

Department of Clinical pharmacy, Pharmacotherapy and Medical Standardization  
Danylo Halytsky Lviv National Medical University, Ukraine

Corresponding author Kateryna V. Kostyana, e-mail: [katya.kostyana@gmail.com](mailto:katya.kostyana@gmail.com)

**Key words:** migraine treatment, rational pharmacotherapy, DRP.

**Introduction:** According to the official WHO data, migraine is one of the most frequent types of primary headaches leading to a significant disability during an acute attack and considered one of the 10 most disabling disorders worldwide.

**Methods:** Research objects were evidence-based medicine data, authoritative clinical guidelines, prescription papers of patients with migraine (n=19) hospitalized to neurological department of one of the hospitals of Lviv region during the period since 1988 until 2012. The study was conducted in May 2015. Methods include descriptive, clinical-pharmaceutical, clinical-pharmacological, statistical, analytical and comparative, bibliographic.

**Results:** While analyzing the prescriptions (the overall number of prescribed medications was 180) we detected 289 drug-related problems (DRP), classified according to adopted version of PCNE V 5.01 into five sections. The prevailing DRPs were as follows: native problems of drug prescription (29.4%), dosing problems (20.4%) and potential drug-drug interactions (19.7%).

**Discussion:** In process of research, we revealed a number of native characteristics for the inpatient antimigraine drug prescription that contradict the basics of rational pharmacotherapy. Those include prevailing polypragmasy, inconsistency between existing practice of migraine pharmacotherapy and the standards, lack of national up-to-date approved guidelines for migraine treatment. The design of the research also gave a chance to track the dynamics of DRP cases during the analyzed period. This revealed no significant changes in DRP occurrence, which means urgency of the explored problem.

**Conclusion:** The results of the research show the necessity of providing physicians with qualified recommendations of clinical pharmacists on rational prescribing of antimigraine agents. Such an intervention to our mind is reasonable. It will help in preventing DRPs thereby improving patients' quality of life.

**Source(s) of research support in the form of financial support, grants:** The investigation was carried out as a part of scientific research of Department of Clinical Pharmacy, Pharmacotherapy and Medical Standardization of Danylo Halytsky Lviv National Medical University, which was funded by state budget. No other financial support provided.

**Acknowledgements:** No special acknowledgements.

**Ethical Committee Approval:** Minutes No. 4, 20 April 2015.

## Determination of Selenium Contents in Some Promising Nephroprotective Legume Plants

Lysiuk R.M.<sup>1</sup>, Zaritska Y.G.<sup>2</sup>, Darmohray R.Y.<sup>1</sup>, Yanovych D.V.<sup>2</sup>

1 - Department of Pharmacognosy and botany at Danylo Halytsky Lviv National Medical University, Lviv, Ukraine;

2 – Laboratory of instrumental methods of control at the State Scientific-Research Control Institute of Veterinary Medicinal Products and Feed Additives, Lviv, Ukraine

The corresponding author: Lysiuk R.M. ; e-mail: [pharmacognosy.org.ua@ukr.net](mailto:pharmacognosy.org.ua@ukr.net)

Key words: selenium, *Astragalus*, legume, *Fabaceae*, nephroprotective

**Introduction:** Chronic renal failure represents a massive problem in the developed world and it is associated with low concentration of serum selenium and lower platelet glutathione peroxidase (GPx) activity (Kuo K.-L., Tarng D.-C., 2010).

Number of specific nephroprotective (hypoazotemic) drugs of plant origin in current pharmaceutical market is rather limited. The family *Fabaceae* is considered a promising plant taxon for the search and further development of new nephroprotective phytopharmaceuticals due to content of robinin and other flavonoids of hypoazotemic activity.

**Methods:** Selenium contents in 11 *Fabaceae* plants was analyzed by atomic absorption spectrometry on VARIAN AA 240Z after mineralization in the microwave Milestone Start D.

**Results** 6 plant species of the genus *Astragalus*, 2 *Robinia spp.*, 2 *Melilotus spp.* and *Galega officinalis*, collected from cultivated and wild plots in the Western and Central parts of Ukraine, were assayed. The selenium contents in investigated legume plants varies from 0,12 to 0,44 mg kg<sup>-1</sup>: its lowest yield was found for *Astragalus falcatus* and *Melilotus officinalis*, and the highest one for *Astragalus ponticus*.

**Discussion:** Selenium has an important role in cellular antioxidant defenses as a necessary component of selenoproteins. GPx are the best-characterized selenoproteins. GPx has been investigated for its protective effect against cisplatin-induced nephrotoxicity. In laboratory animals, parenteral administration of organic and inorganic selenium has been shown to protect against cisplatin-induced nephrotoxicity (Ebadi M.S., 2007).

Glutathione peroxidase helps prevent the generation of free radicals and decreases the risk of oxidative damage to tissues, including the kidney and its vascular components (Smith A.M., Temple K., 1997).

Therefore, the investigation of selenium contents in plants as its possible natural sources is of great significance.

**Conclusion** The studied plant species should be subjected for further pharmacological experiments concerning nephroprotective effects, and the range of their selenium contents might be partly contributed to the latter.

**Source of research support.** None.

**Acknowledgements.** Authors are grateful to J.B. Rakhmetov, DSci. (Agricult.), M.M. Gryshko National Botanical Garden of the NAS of Ukraine (Kyiv), and O.O. Kagalo, PhD (Biol.), Institute of Ecology of the Carpathians of the NAS of Ukraine (Lviv) for collection and identification of some investigated plant sample

## Synthesis and Biological Activity of 5-Substituted 1,4-Naphthoquinones Heterocyclic Derivatives

Marshall O.I.<sup>1</sup>, Polovkovych S.V.<sup>2</sup>, Ogurtsov V.V.<sup>1</sup>

<sup>1</sup> Danylo Halytsky Lviv National Medical University, 69 Pekarska Str., Lviv 79010, Ukraine

<sup>2</sup> National University "Lviv Polytechnic", 12 Stepan Bandera Str., Lviv 79013, Ukraine

olga.marshallok@i.ua

**Keywords:** 5-substituted 1,4-naphthoquinones, polyheterocyclic compounds, regioselective Diels-Alder reaction, antineoplastic activity.

**Introduction:** Polyheterocyclic derivatives of quinoid systems are known as biologically active compounds with a broad spectrum of pharmacological activity. Combination of such compounds with a number of 1,4-quinones derivatives can lead to obtaining new compounds that have the potential to be a selective inhibitors of many biological targets.

**Methods:** Heterocyclic systems can be synthesized by reaction of carbocyclic compounds with alicyclic heterodiene by Diels-Alder mechanism. Reactions of 5-substituted 1,4-naphthoquinones (5-hydroxy, 5-methoxy, 5-amino, 5-nitro, 5-acetoxy-1,4-naphthoquinone) with 2-butenal-N,N-dimethylhydrazone have been carried out in ethanol at 60-75<sup>0</sup>C in the presence of argon, and in toluene in the presence of acetic anhydride. The oxidation of intermediate products have been performed in alkaline ethanol at passing atmospheric oxygen during 24 h.

Research of bactericidal activity have been carried out by standard method of substance diffusion in agar. For the test bacteria cultures *Escherichia coli*, *Staphylococcus aureus*, *Mycobacterium luteum* growth 2% solution of Nutrient Agar have been used. For studying fungicidal activity towards *Aspergillus niger* and *Candida tenuis* 2% solution of Wort Agar have been used.

**Resultus:** Under different conditions dihydrobenzoquinolinedions derivatives have been obtained. Also formation of different products of elimination of two hydrogen protons from the 4a and 10a positions have been observed. Further oxidation results in obtaining of 1,4-quinone derivatives with pyridine ring.

According to *in silico* prediction of biological activity done by PASS program ( $P_a > 0,7$ ) almost all synthesized compounds have potential antineoplastic activity. Antibacterial activity towards *Staphylococcus aureus* and *Mycobacterium luteum* have been determined for some compounds.

**Discussion and Conclusions:** By the analysis of products has been established that the determining factor in the regioselective Diels-Alder reaction is influence of substituent in the 5 position of quinone. Determined probability of antineoplastic activity provides an opportunity to modify synthesized compounds to enhance their biological activity.



## **Methadone: alternative analgesic for palliative patients**

Shunkina S.Ye, Hromovyk B.P.

Department of organization and economics of pharmacy, Danylo Halytsky Lviv National Medical University, Lviv, Ukraine

Corresponding author: Sofiya Shunkina, [sofiyaprokip@gmail.com](mailto:sofiyaprokip@gmail.com)

**Key words:** chronic pain syndrome, palliative patient, analgesia, morphine, methadone

**Introduction:** In pharmacotherapy of moderate and severe chronic pain, which is one of the most common symptoms in 70-80% of palliative patients, opioid analgesics, including morphine, are used. However, in 10-30% of patients proper analgesic effect due to increasing doses of Morphine is not observed because of serious side effects or neurotoxicity. One of the perspective synthetic opioid is Methadone, which is used as a drug for substitution maintenance therapy in the treatment of opiate dependence and practically is not prescribed as analgesic.

The **aim** of our research was to study the possibility of using Methadone as an alternative opioid for pharmacotherapy of chronic pain in palliative patients in Ukraine.

**Methods:** bibliographic, analysis of clinical researches datas (databases Cochrane, MEDLINE and Embase), statistical, comparative and content analysis. In order to assess the effectiveness of compared drugs (Morphine and Methadone) was calculated the odds ratio and indicator "cost-effectiveness".

**Results:** As a result of bibliographic analysis of databases were found five randomized clinical trials, which are related to our topic. Statistical analysis of the results of them had shown that the odds ratio for Methadone compared to Morphine is 1.16. Calculating of the ratio "cost-effectiveness" of morphine and methadone tablet forms in the treatment of chronic pain revealed that it was equal to 17.57 and 1.35 respectively.

**Discussion:** The odds ratio suggests that the therapeutic efficacy of Methadone is not lower than that of Morphine, which enables its use as an alternative drug. The expediency of using Methadone as an alternative analgesic is confirmed by higher economic accessibility (the best ratio "cost-efficiency").

**Conclusion:** The results of a comparative analysis of clinical trials of using Methadone and Morphine in treatment of palliative patients, and also study of economic availability pharmacotherapy found that Methadone may be an alternative opioid to ensure adequate analgesia.

There was nothing funding support for this study.

## Synthesis and Biological Activity Evaluation of Some Novel Thiazolo[4,3-*b*]quinazolines

Chaban Z.I., Klenina O.V., Drapak I.V., Chaban I.G., Ogurtsov V.V., Nektgeaev I.O.  
Department of General, Bioinorganic, Physical and Colloidal Chemistry, Danylo Halytsky Lviv National Medical University, 69 Pekarska Str., Lviv, 79010, Ukraine

Corresponding author: chabanzoryana@ukr.net

**Key words:** thiazolo[4,3-*b*]quinazolines, intermolecular cyclization, pharmacological screening

**Introduction.** The combination of two heterocyclic systems (thiazolidine and quinoxaline rings) both of which are of the high priority in modern medicinal chemistry can be considered as the systematic approach for molecular rational design of drug candidates. Thiazolo[4,3-*b*]quinoxalines are relatively unexplored with regard to their preparation synthetic protocols and biological actions. Thus synthesis and structural modification of novel quinazoline fused analogs is one of nowadays challenges.

**Methods.** Organic synthesis, proton nuclear magnetic resonance (proton NMR, hydrogen-1 NMR, or <sup>1</sup>H NMR), and pharmacological screening were performed.

**Results and discussion.** 2-(2-Oxo-thiazolidine-4-ylideneamino)-benzoic acid (**1**) represents a convenient intermediate in order to afford tricyclic fused thiazolidine analogs. It can construct the cycle with thiazolidone with its edges "c" or «d». It was shown that under the dehydrating agents using the reaction occurs with 3*H*-thiazolo[4,3-*b*]quinazolin-1,9-dione formation (**2**). Cyclization with "c" adge was more probable taking into account the Hydrogen atom in C<sup>3</sup> position high mobility and prevailing cyclization scheme with the internal amide formation.

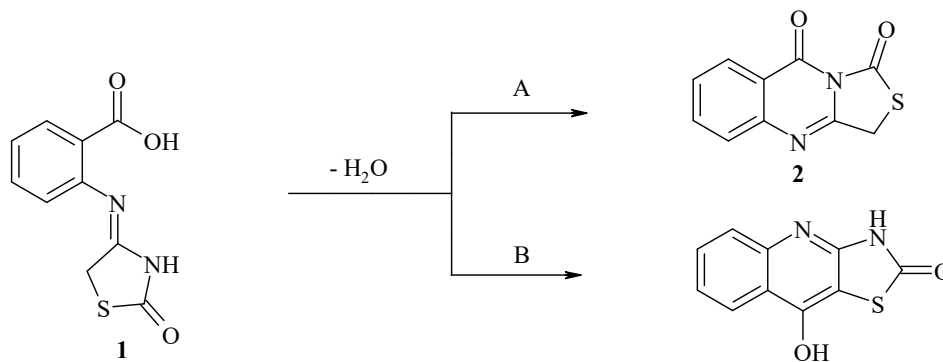

The active methylene group presence in C<sup>3</sup> position provides an entry for its utilization in aldol condensation and azo coupling reactions leading to appropriate 3-arylidene and 3-aryldio derivatives of 3*H*-thiazolo[4,3-*b*]quinazolin-1,9-dione generation.

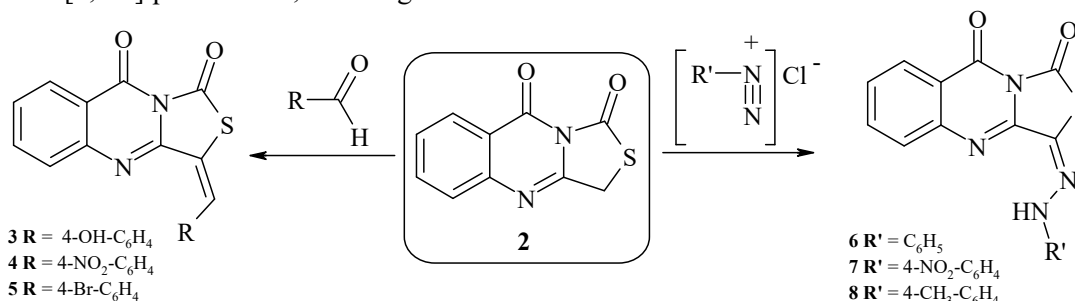

The antioxidant activity was determined *in vitro* as free radical scavenging activity of 2,2-diphenyl-1-picrylhydrazyl (DPPH) free radical. The screening allowed identifying lead compounds **4** and **5** whose free

radical scavenging activities exceed that one for ascorbic acid. The synthesized compounds anti-inflammatory effect evaluation was carried out employing the carrageenan-induced rat paw edema method. Evaluation indicated that compound **4** showed the highest inflammation inhibition rate as 49.0 % protection to inflammation while compound **5** possessed the effect at the level of 43.2 %.

**Conclusions:** The synthetic protocols for thiazolo[4,3-*b*]quinoxaline system construction and its functionalization in fused heterocycle C<sup>3</sup> position *via* aldol condensation and azo coupling was developed. The pharmacological screening of anti-exudative and antioxidant activity of novel compounds was carried out.

Publication is based on the research provided by the grant support of the State Fund For Fundamental Research (project N GP/F61/078).

**Ethical Committee** of Danylo Halytsky Lviv National Medical University, constituted by the Ministry of Health of Ukraine, Approval No. 7 dated February 2, 2015.

**None RECOOP CRRC  
Abstracts: Ukraine  
DHLNMU, Lviv  
Translational Research  
10**

## **Role of cytokines in the mechanisms of the development of chronic catarrhal gingivitis in children living in ecologically unfavorable areas.**

Malko N.V.

Department of pediatric dentistry, Danylo Galytskyi Lviv National Medical University, Ukraine  
79010, Lviv, Pekarska 69 st.  
Tel. 38 (0322) -755-987  
e-mail: malkonatalj@Gmail.com

**Keywords:** children, gingivitis, cytokines, ecological conditions

**Introduction:** In the polluted environmental conditions an activity of the functional response of immune system in children is reduced, and it can lead to development of disease.

**Methods:** 186 children with chronic catarrhal gingivitis (CCG) aged 7 to 16 years, residing in areas with different levels of ecological pollution were observed. The PMA and CPI indices were used for the assessment of periodontal status. Content of interleukins (IL-4; IL-6) in oral liquid was determined with using of solid-phase immunoenzyme assay and the reagents of "Vector-Best" company (Russia) were used for this purpose. The parental written consent was obtained from the participants.

**Results:** The level of cytokine IL-6 in oral liquid in children with CCG living in ecologically unfavorable area was significantly higher ( $17.02 \pm 0.62$ pg/ml) than the level of cytokines in children living in a relatively clean area ( $13.94 \pm 1.41$ pg/ml). The content of cytokine IL-4 in oral liquid in children with CCG from polluted region was lower ( $6.64 \pm 0.61$ pg/ml) than in children living in a relatively clean area ( $8,38 \pm 0,61$ pg/ml). The content of IL-6 in oral liquid in children with slight CCG living in ecologically unfavorable area was as follows:  $15.49 \pm 0.62$ pg/ml. The content of anti-inflammatory cytokine IL-4 in oral liquid in children with slight CCG living in adverse environmental conditions was found to be lower comparing to the corresponding cytokine level in children from a relatively clean area ( $6.72 \pm 0.42$ pg/ml against  $8.06 \pm 0.41$ pg/ml). The lowered content of IL-4 was observed in children with moderate form of CCG living in the contaminated area.

**Discussion and Conclusions:** An increased level of cytokine IL-6 and reduced level of IL-4 has been found in oral liquid in children with CCG living in ecologically polluted area comparing to the children who live in a relatively clean area.

Source of research support is private, paid by myself. No grants.

Acknowledgements: to my scientific adviser Bezvushko E.V.

Ethical Committee approval - 17.03.2014, protocol №3.

## Action of serotonin and mosapride on inflammation, production of NO and lipid peroxidation in colonic mucosa in model of experimental colitis in rats

Denysenko N., Sklyarov A.

Department of biological chemistry, Danylo Halytsky Lviv National Medical University, Lviv, Ukraine

[denysenko.natalka@gmail.com](mailto:denysenko.natalka@gmail.com)

**Key words:** colitis, serotonin, mosapride, 5-HT<sub>4</sub> receptor agonist, 5-HT<sub>3</sub> receptor antagonist  
**Abstract:**

**Introduction.** Serotonin is an inflammatory mediator, which causes changes in microcirculation in the damaged tissue and relaxation of smooth muscles of the colon through stimulation of serotonin receptors - 5-HT<sub>4</sub> and 5-HT<sub>3</sub> receptors. About 95% of serotonin in the human body is contained in the mucous membrane of the digestive tract (EC-cells). We assume that regulation of serotonin content and the type of receptor to which it will operate may affect the course of inflammation in colon.

**Methods.** 40 rats were used for this investigation and were divided into 4 groups: control (vehicle treated), acetic acid colitis (AAC), AAC + serotonin, AAC + mosapride. After euthanasia colons were examined and the area of inflamed colonic mucosa (CM), damage index and activity of MPO, NOS, SOD, catalase, arginase, concentration of MDA, L-arginine, total nitrites and nitrates were established in CM homogenates.

**Results.** Administration of serotonin caused the increase of area, severity of inflammation and minor changes of studied biochemical parameters compared to AAC. Effect of mosapride was converse: the area of inflammation, damage index of CM, MPO, SOD, iNOS activities decreased by about 21-40%.

**Discussion.** The results of macroscopic and histological studies give reason to believe that serotonin may significantly enhance the AAC in rats perhaps by changing the microcirculation in the inflamed area. But we have not set the gain of oxidative processes that may be due to the antioxidant properties of serotonin. Mosapride demonstrated anti-inflammatory effect that may be caused by agonism of 5-HT<sub>4</sub> receptors or antagonism of 5-HT<sub>3</sub> receptors by its main metabolite.

**Conclusion.** The role of serotonin in the development of inflammation is ambiguous and depends on the type of receptor to which it will operate. In particular, the stimulation of 5-HT<sub>4</sub> receptors leads to decrease the inflammation in CM of rats under conditions of AAC.

The study was conducted by Danylo Halytsky Lviv National Medical University Protocol number 3 of the Commission of Ethics of Danylo Halytsky Lviv National Medical University, March 16<sup>th</sup>, 2015.

## **Morphology and lectin histochemistry of rat liver after the prolonged Loratadine administration**

Dudok O.V.

Department of Histology and Embryology, Danylo Halytsky Lviv National Medical University  
E-mail address: Sunsea707@gmail.com

**Aim.** To investigate influence of long term administration of antihistamine drug Loratadine on morphology and carbohydrate determinants of hepatic tissues.

**Material and methods.** Experiments were conducted on 14 Wistar rats. Each rat of experimental group (including 7 animals) once a day orally during 30 days received Loratadine at a dose of 0.15 mg/kg body weight. On days 10, 20 and 30 after the last administration of Loratadine samples of liver were excised and prepared to light and electron microscopic investigation using routine protocols. Carbohydrate determinants were detected by lectins Con A, WGA and SBA.

**Results.** Light microscopy after haematoxylin and eosin revealed expansion of sinusoidal haemocapillaries, cytoplasmic and nuclear hyperchromia, hydropic dystrophia of hepatocytes. Submicroscopically it was detected increased electron density and enhanced content of lipid inclusions within the cytoplasm of hepatocytes, some of which demonstrated hyperplasia of smooth endoplasmic reticulum. In within the Disse space it was documented the accumulation of fibroblasts and plasma cells, as well as the cells of Kupffer and Ito. On the day 30 of experiment a large number of hepatocytes exposed abundant free ribosomes in the cytoplasm – the sign of intracellular regeneration. Out of the lectins used most informative were SBA and WGA. Namely, after the Loratadine administration binding of SBA to cytoplasmic and nuclear glycoconjugates of hepatocytes was significantly higher than that in control specimens. On the contrary, liver of intact rats demonstrated intense WGA labeling of plasma membrane, cytoplasmic and nuclear glycoconjugates of hepatocytes, this intensity of binding significantly decreased after the Loratadine administration. Detected changes indicate reduction of terminal DGlcNAc and NeuNAc, combined with the increased exposure DGalNAc residues, apparently due to incomplete glycosilation of liver carbohydrates.

**Discussion - Conclusion.** Prolonged Loratadine administration has certain destructive effects on micro- and ultrastructure of liver, as well as induces modification of its carbohydrate determinants.

**Key words:** antihistamine drugs, Loratadine, lectin histochemistry, liver

Danylo Halytsky Lviv National Medical University Ethical Committee Approval: February 24, 2014, Protocol # 2. All manipulations with animals were carried out according to the provisions of Strasbourg Convention (

## **Changes of the links hemomicrocirculatory flow of the mouth angle and lip in the rat on late stages of experimental streptozotocin-induced diabetes.**

Y.Hnidyk,

Department of Normal Anatomy, Danylo Halytsky Lviv National Medical University Lviv, Ukraine

[julya.h@hotmail.com](mailto:julya.h@hotmail.com)

**Key words:** diabetes, mouth, lip, rats, capillaries

**Introduction:** As the number of people with diabetes grows worldwide, the disease takes an ever-increasing proportion. In modern diabetology the most topical problem is affection of the capillary network, which is visible almost in all organs and tissues and provides the development of significant complications occurred as microangiopathy and macroangiopathy in different types vessels, leading to diabetic cheilitis.

**Materials and methods:** Male white adult rats (weight 100 - 130gr.) were taken. Animals were injected by streptozotocine single in a dose 7 mg/100gr. The biological samples (mouth angle and lip) were taken every 2 weeks (after the control of glucose level in the blood), under thiopental anesthesia. Tissues of the cheek's mucosa and mouth corner were examined under a magnifying glass. Mucous patterns were taken by surgery cutting and fixed in 10 % formalin solution, then were made transparent cross- sections through the entire thickness of the tissues, size 2 - 3 mm. Preparation of histological patterns carried out by the method of staining with hematoxylin, eosin and azan. The experiment was approved by the University Animal Care and Use Bioethical Committee (protocol#5/17MAY2010)

**Results:** At the end of 8 and 10 weeks of experiment we have found that body weight decreased progressively, the animals completely lacking accurate behavior. Visually marked dryness of the mucous membrane of the gums, severe congestion of the mouth's mucous membrane, on the periphery develops gingivitis, cyanosis, dystrophic phenomenon that lead to the foci of necrosis. There is occurrence of lip mucous multilayered epithelium with signs of increased keratinization. Horny layer is wide, in a granular layer keratinocytes have large basophilic granules. Among epithelial cells of basal and spinous layers where are cells with nuclei irregular shape and invaginations of kariolema. Karioplazma much basophilic, nucleoli compact, small. This reflects the low functional cores' activity.

**Conclusion:** As a result of our post-mortem microstructural studies mucous lips, corner of the mouth and parts of hemomicrocirculatory bed on 8 and 10 weeks we have found the phenomenon of increased acanthosis and hyperkeratosis, deep in the mucosa of lamina propria - swelling round cellular focal infiltration, appears group with open capillary lumen, walls' thickening of arterioles and venules.

There are defined changes of the epithelium, swelled connective tissue of mucous tunic. Expanded and filling with blood veins, and narrowed arteries with the thickened wall of different caliber. Changes that occurred in capillary link are manifestation of the reaction of vascular bed modeled by the diabetes, which occurs hard pathologic biochemic changes.



## **Exploiting Hydrogen Sulfide of Novel 4-Thiazolidinone Derivatives in Cytoprotection of Small Intestine under Indometacin-Induced Injury**

I. Ilkiv, O. Sklyarov

Department of Biochemistry, Danylo Halytsky Lviv National Medical University, Lviv 79010, Ukraine

Corresponding author: Iryna Ilkiv, ira9ilkiv@gmail.com

**Key words:** hydrogen sulfide, small intestine, indomethacin-induced injury, 4-thiazolidinones.

**Introduction.** Various endogenous and exogenous (NSAIDs, stress) agents can lead to gastrointestinal mucosa injury. Considerable interest belongs to mucosal defense factors such as prostaglandins, nitric oxide and H<sub>2</sub>S. For this reason, the purpose of our study was to investigate the influence of novel 4-thiazolidinone, which release H<sub>2</sub>S, in protective mechanisms of small intestine.

**Methods.** The experiment was performed on 40 white rats. Indometacin-induced injury (IMII) caused in the ulcerogenic dose (35 mg/kg, subcutaneously). A series of 4-thiazolidinones (Les-5054 and Les-5055) were administered three times intragastrically at a single dose 10 mg/kg. In homogenates of the mucous of small intestine (MSI) were determined the activity of NO-synthases, myeloperoxidation, superoxide dismutase (SOD), the content of nitrite anion (NO<sup>2-</sup>) and MDA.

**Results.** The activity of iNOS in MSI increased in 2 times, as well as the content of MDA and NO<sup>2-</sup> (p<0,05; 43% and 138 % respectively) under condition of IMII as compared to the indices of the control group. Les-5054 on the background of IM effect decrease activity of iNOS for 38 % as well as content of MDA and NO<sup>2-</sup> (p<0,05; 29 % and 57 % respectively) and increase the activity of cNOS for 37 % (p<0,05) compared with indices of IMII group. Parameters of NO-synthase system in Les-5055-treated group showed the same tendency as under the effect of Les-5054.

**Conclusion.** The preliminary results allowed us to identify the tested compounds as perspective H<sub>2</sub>S-donors in the searching of cytoprotective agents among biologically active 4-thiazolidinones.

**Acknowledgement:** Thank you for Cedars Sinai Medical Center's International Research and Innovation Management Program, the Association for Regional Cooperation in the Fields of Health, Science and Technology (RECOOP HST Association) for their support of our organization as participating Cedars-Sinai Medical Center-RECOOP Research Centers (CRRS).

**Ethical Committee or Institutional Animal Care and Use Committee Approval:** 16/03/2015 № 3

## Changes in Antioxidant System and Lipid Peroxidation after Administration of Nalbuphine in Rats' Liver.

Logash M<sup>1</sup>, Pokotylo P<sup>1</sup>, Fedevych Y<sup>2</sup>

Department of normal anatomy<sup>1</sup>. Department of biochemistry<sup>2</sup>. Lviv National medical university. Ukraine.

Corresponding author: Logash Maksim [maxlohash@gmail.com](mailto:maxlohash@gmail.com)

Key words: nalbuphine, liver, lipid peroxidation, enzyme, opioid

**Introduction:** Nalbuphine hydrochloride administration causes changes in antioxidant system. The nalbuphine metabolism mainly passes in the liver and this organ first comes under the oxidative stress. Thus, the aim of this project was to research the enzymatic component of the antioxidant system and intensity of lipid peroxidation in the liver of rats after nalbuphine administration.

**Materials and methods:** Male white rats were taken, body weight 190-220 gr.. The animals were injected with nalbuphine hydrochloride every day in a dose 0,9 mg/kg. The dose was estimated based on average daily dose in consumers who used nalbuphine with non-medical purpose, which was found in literature, as well as from experimental data. After 7-th days the liver for histology and biochemical analysis (malonaldehyde (MDO), superoxide dismutase (SOD), catalase (CAT), glutathione peroxidase (GPX), glutathione-S-transferase (GST)) was taken after the ether anesthesia.

**Results:** Parameters means (unit - experimental group mean $\pm$ sd (control group mean  $\pm$ sd)): SOD UI\*10<sup>2</sup> - 37,6 $\pm$ 4,1 (23,7 $\pm$ 4,9); CAT  $\mu$ mol H<sub>2</sub>O<sub>2</sub>/min/ $\mu$ g protein - 9,8 $\pm$ 0,9 (7,9 $\pm$ 1,3); MDO  $\mu$ mol/l - 334 $\pm$ 39 (377 $\pm$ 94); GPX  $\mu$ mol GSH/min/ $\mu$ g protein - 4,53 $\pm$ 0,81 (1,09 $\pm$ 0,24); GST  $\mu$ mol GSH-S-conjugate/min/mg protein - 26,9 $\pm$ 4,7(26 $\pm$ 12,3).

**Discussion and conclusion:** Nalbuphine administration caused well-expressed changes in peroxide-utilizing system of rats' liver. SOD activation demonstrated increasing level of O<sub>2</sub>-radical and as a result of this – activation of CAT and GPX as main enzymes for H<sub>2</sub>O<sub>2</sub> detoxification. Moreover, the GPX is a main enzyme for utilization at low level H<sub>2</sub>O<sub>2</sub>, while CAT activated in a case of higher intracellular H<sub>2</sub>O<sub>2</sub>, thus, the hydrogen peroxide level is significantly high. But decreasing of MDO, which is a main indicator of lipid peroxidation, is a possible evidence of some scavenger presence. Thus, we can suggest, that nalbuphine can absorb the H<sub>2</sub>O<sub>2</sub>, similar to morphine. Unchanged GST level demonstrates, that mainly phase I of xenobiotics' detoxification activated.

**The University Animal Care and Use Committee Approval:** protocol #2 from 20.02.2012

## Assessment of Cytotoxic Action of Hepatoprotector Antral on Bulls Sperm

Kuzminov B.P., Matysik S.I.

*Department of Hygiene and Preventive Toxicology, Danylo Halytsky Lviv National Medical University*

*The corresponding author's: Matysik S.I. E-mail: lana77matysik@gmail.com*

**Key words:** Antral, cytotoxicity, bulls sperm.

**Introduction:** Modern toxicological researches foresee determination of dangerous of chemicals on cells' cultures. The aim of this research was to assess cytotoxic effect of hepatoprotector Antral on bulls sperm.

**Methods:** Cytotoxic effect was studied in freshly obtained ejaculates of bulls which had the following characteristics: volume 4.5 ml, concentration of spermatozoa  $0,7-1,2 \times 10^9$  cells/ml, the alieving cells 70-85%. Sperm was the controller sparsed with the helped phosphate-buffer saline (PBS), research groups are the sperm with the addition of the PBS Antral doses 1/500 and 1/100 LD<sub>50</sub>. Survival of sperm was determined in stored sperm at temperature 2-5°C, respiratory activity was noted in polarographic way and recovery activity – by potentiometrically.

**Results:** Incubation by 1/500 LD<sub>50</sub> dose reduces oxygen consumption on 58.8% (P<0.01) and restorative activity on 66.7% (P<0.001), by 1/100 LD<sub>50</sub> dose – respectively on 68.5 and 54.5% (P<0.01) in comparison with control. Action of 1/100 LD<sub>50</sub> dose reduces sperms' survival on 27.8% (P<0.01) in comparison with control.

**Discussion:** Antral in both doses causes practically identical changes of intensity of oxidative processes in cells' cultures, but 1/100 LD<sub>50</sub>, probably, inhibits way of substrate use and the formation of macroergic compounds and it influences the structure of cells, which reduces the survival of sperm. Thus, the threshold dose is 1/500 LD<sub>50</sub>. Impact of Antral approves the strong correlation between doses of pharmaceutical and the respiratory and restorative activities (respectively  $\eta^2 = 0.762$  and  $0.824$ ), and the average correlation with the survival of sperm ( $\eta^2 = 0.438$ ).

**Conclusion:** Antral action on bulls' ejaculates is dose-dependent, characterized by a decrease of oxygen consumption and survival of spermatozoa with increasing pharmaceutical dose. To identify mechanisms of action on certain parts of cell metabolism and assessment of cytotoxicity is advisable to conduct a comprehensive study of their biological effects on bulls sperm based on indicators of oxidative processes and survival of germ cells.

Research is conducted by own funds.

**Acknowledgements:** The authors gratefully acknowledge the consultation assistance of Dmytro Ostapiv, Doctor of Agricultural Sciences, Institute of Animal Biology of National Academy of Agrarian Sciences of Ukraine, who helped in cytological studies.

**Ethical Committee** of Danylo Halytsky Lviv National Medical University: March 16, 2015; N 3.

## **Hemo-microcirculatory vessel bed of white rat kidney under condition of experimental diabetes**

Pokotylo P.B., Halyuk U.M., Mateshuk-Vatseba L.R. .

Department of Normal Anatomy Danylo Halytsky Lviv National Medical University, Pekarska st., 69, Lviv, 79010, Ukraine

Corresponding author: Petro Pokotylo – e-mail: [anatompetro@gmail.com](mailto:anatompetro@gmail.com)

**Key words:** white rat kidney, hemo-microcirculatory vessel bed, diabetes.

**Introduction:** Globally as of 2014 that there were 6% of adult population with type 2 diabetes. Thus, the aim of the study was to investigate the hemocirculatory vessel bed of white rat kidney on the 56-th and 70-th days of the experimental streptozotocyn (STZ)-induced diabetes.

**Materials and methods:** The male white pubertal rats weighing between 180-200 g were used in these experiments and divided for 3 exercise groups: the 1<sup>st</sup> group – 15 animals with a single intraperitoneal injection of “Streptozotocyne” – 70 mg/kg; the 2<sup>nd</sup> control group 15 animals with the injections of 1 ml 0,9% NaCl, and the 3<sup>rd</sup> group – 15 intact animals. Morphological ( histological, morphometric), biochemical and statistical methods of study were used in our work.

**Results:** After 56 days of the experiment, the arcuate and interlobular arteries became dilated, often ended blindly. The hemocapillary vessel bed of the kidney was destroyed. The number of renal corpuscles with partial or complete atrophied glomerular capillaries increased. On the 70<sup>th</sup> day of STZ-induced diabetes only single kidney hemocirculatory vessel bed fragments, without capillary components, were observed. Renal corpuscle capsules were deformed, sometimes discontinuous.

**Discussion and conclusion:** On the 56<sup>th</sup> day of the experiment the “shriveled” glomerular capillaries as well as the dilated glomerular capsules were observed. On the 70<sup>th</sup> day the necrotic processes in renal corpuscles, glomerular capillaries atrophy and the damage of both layers of glomerular capsule were observed. The study serves a morphological basis for appropriate use of the kidney of these experimental animals to create biological models of diabetic nephropathy.

The experiments were approved by the University Animal Care and Use Bioethical Committee: **Protocol #1. 22 January 2007.**

## **Morphometric analysis of bloodstream in white rat testis in streptozotocin induced diabetes.**

I. Savka<sup>1</sup>, T.Savka<sup>2</sup>

<sup>1</sup>Department of General Anatomy, Danylo Halytskyi National Medical University of Lviv, Ukraine;

<sup>2</sup>Regional Clinical Hospital of Lviv, Ukraine

Corresponding author: Iryna Savka [iryna\\_5@ukr.net](mailto:iryna_5@ukr.net)

**Key words:** testis, hemomicrocircular channel, diabetes mellitus.

**Introduction:** Streptozotocin-induced diabetes in rats is frequently used to study the disturbances in lipid metabolism under diabetic conditions. The main complication is a disease of the blood vessels, which we call angiopathy.

**Methods:** The researches have been performed on 20 white mature male rats aged 4.5 to 7.5 months with body weight of 130 to 150g. Experimental diabetes modelling was intraperitoneal injection of Streptozotocin (“Sigma”, USA), dissolved in 0.1M citrate buffer, pH=4.5 (7mg per 100g of body weight of animals). Animals in whose blood glucose concentration in 2,4,6,8 weeks after launch of experiment was above 13.4 mmol/l were used for research.

**Results:** In 6 weeks of experiment run we see vessels are dilated, arterioles and venules are dilated, twisty. Arteriolo-arteriolar as well as arteriolo-venular anastomoses are dilated as well. After 8 weeks of streptozotocin-induced diabetes mellitus run we see deep destructive changes in all testicle hemomicrocircular channel links. Diameter of preserved capillaries is  $9,93\pm 0,03$   $\mu\text{m}$  and  $7,47\pm 0,06$   $\mu\text{m}$  of longitudinal and latitudinal respectively. Arterioles are dilated, their diameter is  $30,56\pm 0,13$   $\mu\text{m}$ , twisty, venules are dilated with diameter of  $31,92\pm 0,04$   $\mu\text{m}$ .

**Discussion and Conclusion:** The morphological and morphometric analysis of testicle angioarchitecture allowed evaluating its vascularization state in the norm and in streptozotocin-induced diabetes mellitus. The depth of diabetic structural changes in the white rat testicle blood channel links correlates with morphometric values. Testicle trophic activity index to  $84,40\pm 1,50$   $\mu\text{m}$  state on significant thinning of testicle capillary network in the experimental diabetes mellitus that leads to its abrupt circulatory failure.

Danylo Halytskyi National Medical University of Lviv **Animal Care and Use Committee Approval:** № 8 of 18 November 2013.

## The Influence of Long-Term Treatment with Monosodium Glutamate on Gastric Acid Secretion in Rats

Savytska M.Ya.<sup>1</sup>, Falalyeyeva T.M.<sup>2</sup>

<sup>1</sup>Department of Physiology of Danylo Halytskyi Lviv National Medical University, Ukraine;

<sup>2</sup>Department of Pharmacology and Experimental Pathology of Taras Shevchenko National University of Kyiv, Ukraine.

Corresponding author: Dr., PhD. Savytska M.Ya., e-mail: [merymed11@gmail.com](mailto:merymed11@gmail.com)

**Key words:** monosodium glutamate, gastric acid secretion.

**Introduction.** Well known flavour enhancer – monosodium glutamate (MSG), E621 is widely used in food industries. For today no data about influence of the prolonged consumption of MSG on gastric secretory function, the violation of which underlies the pathogenesis of many diseases of gastrointestinal tract. Therefore, the aim of this work was to study the effects of long-term introduction of MSG on basal GAS in rats.

**Methods.** Basal GAS was investigated on 36 male Wistar rats, weighing 145-180 g by method of stomach perfusion. Investigated the influence of 10, 20 and 30-days treatment with MSG in doses 15 and 30 mg/kg (daily, per os), which correspond to 1 and 2 g for human. We chose these doses because due to the literature 1 g MSG has no inauspicious action on the human (Geha et al., 2000), but 3 g are hazardous to health (Altman et al., 1994).

**Results.** It was established that 10-day treatment with MSG in dose of 15 mg/kg has no effect on basal GAS. Lengthening the duration of its introduction to 20 and 30 days increased the production rate of GAS in 98% ( $p<0.05$ ), 101% ( $p<0.05$ ). Doubled daily dose of MSG (30 mg/kg) show much stronger effect on the secretion of hydrochloric acid in the stomach of rats. After 10, 20 and 30 days of its introduction debit of basal GAS in the stomach of rats were respectively increased by 81% ( $p<0.05$ ), 352% ( $p<0.01$ ) and 254% ( $p<0.05$ ) compared to control.

**Discussion and Conclusion.** We conclude that the stimulation of basal GAS in the stomach by MSG may be in root of the pathogenesis of a number of acid-related diseases, and excessive consumption of MSG can lead to a syndrome «Chinese Restaurant», gastritis and ulcer disease of stomach and duodenum.

**Financial support.** The Ministry of Education and Science of Ukraine.

**Acknowledgments.** The authors express their sincere thanks to Prof. Beregova T.V. for the help and advice of this work.

**Ethical Committee:** The protocol was approved by the Committee on the Ethics of Animal Experiments of the Taras Shevchenko National University of Kyiv (Protocol number: 25/2015).

**None RECOOP CRRC  
Abstracts: Ukraine  
DHLNMU, Lviv  
Microbiology  
1**

## **Bacteriological research of microflora of the rat's oral cavity under the action of opioid analgesics**

Fik V.B., Fedechko Y.M., Paltov E.V.

Department of Normal Anatomy Danylo Halytsky Lviv National Medical University, Pekarska st.69, Lviv, 79010, Ukraine

Corresponding author: Volodymyr Fik – e-mail: [fivol@ukr.net](mailto:fivol@ukr.net)

**Key words:** rat oral cavity, microflora, opioid analgesics

**Introduction:** According to the literature, in dental system of opioid addict people develop significant changes which form in the oral cavity focuses of chronic infection, where the role of microbial factors in the development of pathological conditions not in doubt.

Research is conducted on rats-males, the material was performed after 2, 4 and 6 weeks at the action of opioid analgesics. Animals accounted into three experimental groups: group 1 - control was administered 0,9 NaCl, group 2 - intact rats, the third group - the animal, which was administered daily opioid analgesics "Nalbufin".

**Method:** Microbiological research microflora of the oral cavity included bacteriological crops from vestibule of oral cavity, tooth plaques on nutrient media in order to assess specific and quantitative composition of microflora.

**Results.** After 2 weeks of administration of opioids, in group 3 animals showed the presence of *E. coli*, reduce streptococci nonhemolytic and the sharp increase in  $\alpha$ -hemolytic streptococci and staphylococci coagulase-negative. After 4 weeks, the number of  $\alpha$ -hemolytic streptococci, staphylococci coagulase-negative and *E. coli* almost doubled. Hemolytic staphylococci and *E. coli* appeared with hemolytic properties. After 6 weeks is showed a significant increase the number of hemolytic staphylococci and *E. coli* with hemolytic properties and appearance of colonies of isolated fungi *Candida*.

**Discussion.** Opioid analgesics prolonged exposure leads to dysbiotic changes which are manifested in the increasing number of pathogenic microorganisms, including hemolytic streptococcus, *E. coli*, and appearance of pathogenic staphylococci against the background of reduction representatives saprophyte microflora, indicating the etiological role of bacteria.

**Conclusions.** Changes of microbiocenosis indicate that arises dysbiosis, accompanied by dynamic development of inflammation in parodontal tissues and oral cavity under prolonged action of opioid.

All experiments were approved by the Danylo Halytsky Lviv National Medical University Animal Care and Use Bioethical Committee **Protocol #2, 20 Feb 2012.**



**None RECOOP CRRC  
Abstracts: Ukraine  
DHLNMU, Lviv  
Health Technology  
1**

## **Usability and Advisability of Health Technology Assessment Core Model in Ukraine on the Example of Gynecological Diseases**

Piniashko O.B., Zalis'ka O.M.

Department of Management & Economy of Pharmacy, Medicine Technology and Pharmacoeconomics, Postgraduate Faculty, Danylo Halytsky Lviv National Medical University  
Corresponding author: Oresta Piniashko [orestapb@gmail.com](mailto:orestapb@gmail.com)

**Key words:** HTA, Core model, endometriosis.

**Introduction:** As a multidisciplinary process Health Technology Assessment (HTA) is used in order to provide objective and rational national health care policy with the limited public budgets in health care in the developed countries. Every HTA report contains a numerous amount of different data. Structure, quality and methodology of performance may differ a lot. HTA Core Model® has been developed to solve this problem in the way of choosing the appropriate criteria for the assessment.

**Methods:** We have analyzed the Ukrainian and international scientific publications with the use of PubMed, EMBASE, internet resources. HTA was performed based on the methodology of HTA Core Model® and the main approaches were adopted in Ukraine.

**Results:** HTA Core Model is a system of standartized HTA. Core Model is a methodological basis for preparing of the reports, which consist of assessment elements. HTA Core Model considers health technologies through nine domains: health problem and current use, description and technological characteristics, safety, clinical effectiveness, costs and economic evaluations, ethical anakysis, organisational aspects, social and legal aspects. So this one common methodology of assessment was constructed, and the comparison between two alternative technologies can be made very objectively by selection of the key parametres.

We have conducted the assessment of alternative treatment schemes due to the methodology of Core Model on the example of management of endometriosis, which has a high incidence and a significant burden on health care in Ukraine and have described the option of the most cost-effective treatment: either laparoscopic surgery or hormonal treatment to release symptomatic pain and increasing the parameters of quality of life in women with endometriosis.

**Discussion:** The HTA Core Model is a novel approach and it implementation into practice in Ukraine. It enables effective international production and sharing of HTA results in a structured format.

**Conclusions:** We have presented, that multicriteria approach with using of HTA Core model and estimation of key priorities of studies provide objective and transparent decision-making process and effective policy in health care and pharmaceutical providing.

**None RECOOP CRRC  
Abstracts: Ukraine  
DHLNMU, Lviv  
Out of the Scope of RECOOP  
Research Strategy: Common  
Mechanism of Diseases  
Dentistry  
11**

## Evaluation of Dental Status of Children Who Live in Territories with Low Fluoride And Iodine Content

Melnyk V., Horzov L.

Children Dentistry Department, State Higher Educational Establishment «Uzhgorod National University», Uzhgorod, Ukraine

[melnik-volodimir@mail.ru](mailto:melnik-volodimir@mail.ru)

[lyudmila\\_buley@list.ru](mailto:lyudmila_buley@list.ru)

**Key words:** children, fluorine, prevalence, intensity.

**Introduction.** Ukraine is a region which has developed adverse medical and social situation involving naturally caused by iodine deficiency in the biosphere. The problem of micro-and macroelements lack, fluorine and iodine in the Transcarpathian region remain acute today. Iodine deficiency, low content of macro- and microelements in the environment affects not only the disruption of the thyroid gland and organism as a whole, but also the state of dental health of people living in different areas of the region.

**Methods.** We have examined 300 children. They were divided into 2 groups of boys and girls: 144 boys and 156 girls. Examination card were developed on the basis of cards WHO to record research results. We determined the prevalence and intensity of caries. Oral hygiene status of children was assessed by index OHI-S (Green-Vermilion, 1964).

**Results and discussion.** Among 6 years pupils carious lesions of teeth was  $92,8 \pm 2,81\%$  cases. Intensity decay in deciduous teeth was high and amounted to  $4,73 \pm 0,27$  temporary tooth on one examined, and in the alternating bite caries intensity was  $5,44 \pm 0,40$  teeth per pupil. Prevalence of dental caries among 9 years children was  $50,56 \pm 5,30\%$  of all children whose intensity was  $1,40 \pm 0,17$  permanent tooth for one examined. Average index OHI-S in the examined pupils was  $1,98 \pm 0,05$  points, as recommended by WHO is treated as high.

**Conclusion.** It was discovered that prevalence and intensity of dental caries considerably high in children who live in territories with low fluoride and iodine content. Among children 6 years old boys are more affected by caries ( $97,67 \pm 2,30\%$ ), than girls ( $87,80 \pm 5,11\%$ ). Examination data showed that indicator of unsatisfactory oral hygiene found in 105 persons and bad oral hygiene in 62.

The experimental protocols have been approved by the local **Ethics Committee** (18.03.2015 № 8).

## **Biological Variation Indices of Protein Metabolism of Oral Fluid and Blood Serum in Patients with Generalized Periodontitis with Different Blood Group Membership**

Bandrivsky Y. L<sup>1</sup>., Bandrivska O. O<sup>2</sup>., Bandrivska N. N<sup>3</sup>.

Department Of Paediatric Dentistry Ternopil State Medical University<sup>1</sup>

Department Of Orthopaedic Dentistry Ternopil State Medical University<sup>2</sup>

Department Of Therapeutic Dentistry Danylo Halytsky Lviv National Medical University<sup>3</sup>

bandrivsky.83@gmail.com

**Key words:** blood, periodontitis, protein metabolism

**Introduction.** The uniqueness of each individual and its set of genes reveals widely varying physiological and pathophysiological response in a group of people in response to the impact of the same factors. Information about the susceptibility or resistance to infectious diseases and infectious nature related to group affiliation of blood are rare.

The need for non-invasive research methods associated primarily with the growth of transfusion-transmissible diseases, causes the urgency of finding alternative blood body fluids. Oral fluid is a biological fluid which provides full not invasiveness, frequent, comfortable and almost not limited by volume capture material. This creates the opportunity to study performance in the oral fluid exchange during the first screening studies.

The purpose of this research is to improve the efficiency of diagnosis by installing natural borders of metabolic fluctuations and structurally functional properties of blood cells and oral fluid associated with blood group in patients with generalized periodontitis.

**Methods.** In blood and oral fluid 260 patients with generalized periodontal disease and 112 healthy people with different blood group membership clarifying concentration of total protein, albumin, urea, C-reactive protein and contents of immunoglobulin A, M, G. Studies conducted on automatic biochemical analyzer "Hitachi- 902"

**Results.** As a result of studies in patients with generalized periodontitis identify significant imbalance in terms of protein metabolism blood and oral fluid compared with those in healthy people. Investigated that carriers 0 (I) and A (II) blood types, patients with generalized periodontitis, changes in the values of indices of protein metabolism serum and oral fluid expressed brighter than the representatives from B (III) and AB (IV) groups blood.

**Conclusions.** Changes in protein metabolism of oral fluid and blood serum in patients with generalized periodontitis suggest an acute response to inflammation, stress nonspecific and specific defense mechanisms, endogenous intoxication, and this trend is more pronounced in patients with generalized periodontitis, carriers 0 (I) and A (II) blood groups.

Ethical committee approval: The Commission of Bioethics SHEI "Ternopil State Medical University I. Gorbachevskogo Ministry of Health of Ukraine" From September 1, 2015

## Medical Activity of Patients with Inflammatory Periodontal Diseases Working in Conditions of Agricultural Production

Author: Dyryk V.T. (assistant/dentist)

Name of the department

to which the work is attributed: *Department of Therapeutic dentistry*

Name of the institute

to which the work is attributed: *Danylo Halytskyi Lviv National*

*Medical University*

Corresponding author *Dyryk V.T.*

*\*\* The work experience in scientific activity: 9 publications in journals of Ukraine, 2 publications in the foreign journals.*

*\*\*\* Author is a member of Association of Dentists and Periodontists of Ukraine.*

E-mail address: [vlodzja\\_dyryk@ukr.net](mailto:vlodzja_dyryk@ukr.net)

Postal Address: *79000, Ukraine, Lviv,*

*Leontovycha 9 street, fl. 11a.*

**Introduction.** The perfection of treatment and prevention activity consists not only of the development and implementing of the modern methods of treatment in practical medicine for the prevention of dental morbidity but also from active participation of patients in this process. Given that dental plaque is etiopatogenetic factor in the development of caries and inflammatory periodontal diseases, important became the health care of oral cavity in patients.

**The aim** of article is to study the level of medical activity and hygienic awareness in patients that have been diagnosed with inflammatory-dystrophic changes in periodontal tissues.

**Material and methods.** The study was conducted with method of social survey with specially designed questionnaire, the questions which touched upon such aspects as frequency and mode of cleaning teeth, use of additional subjects and hygiene of the oral cavity, awareness of patients about the relationship between oral health.

**Results.** 240 patients, among them 140 persons presented by men (58.33%) and 100 persons presented by women (41.67 %) aged 20-55 years, mean age was  $34.18 \pm 0.66$  years in examined. The analysis of subjective complaints in patients conducted the next most frequently symptoms: the periodic appearance of a sour taste in the mouth complained 98 patients ( $47.57 \pm 3.48$  %), the coating on the tongue defined  $30.58 \pm 3.61$  % of respondents (63 persons). Bleeding gums and bad breath noted by 23.0 % of respondents (48 and 49 respectively). The advanced dental complaints not have only 29 from 240 respondents. It was found that most respondents had a low level of medical activity. The recommendations of the dentist was not fulfilled  $43.40 \pm 3.20$  % of respondents,  $69.30 \pm 2.98$  % of patients treated with dental care had not completed treatment.

**Conclusions.** Thus, the analysis of hygienic behavior and medical activity in patients, found their low level, with the knowledge about oral hygiene in most patients is insufficient.

**Key words:** oral hygiene, medical activity.

**Missing Ethical Committee Approval**

## **Application of Vector-therapy and Photoactivation disinfection in Periodontology**

Lychkovska O.L.<sup>1</sup>, Melnychuk H.M.<sup>2</sup>

<sup>1</sup>Danylo Halytskyi National Medical University, Lviv, Ukraine

Department of Therapeutic Dentistry

<sup>2</sup>Ivano-Frankivsk National Medical University, Ivano-Frankivsk, Ukraine

Department of Pediatric Dentistry

Corresponding author: Lychkovska Oleksandra; email: [flowersandra@gmail.com](mailto:flowersandra@gmail.com)

**Keywords:** generalized periodontitis, photoactivation disinfection, Vector.

**Introduction:** important in the treatment of patients with generalized periodontitis (GP) is the introduction of new methods to improve treatment - Vector-therapy combined with photoactivation disinfection (PAD).

**Methods:** The study involved 22 patients, aged 20 to 44 years, with chronic GP initial course, I and II stage of progress. Clinical assessment of the index and radiovisiography periodontal examination was conducted. Depending on the treatment of GP, patients were divided into two groups: A-main (12 patients) and control-B (10 patients). Patients of the main group in the complex treatment conducted Vector GP-PAD and laser diode "Granum" and methylene blue (photosensitizer)

Clinical diagnosis was determined: index Green-Vermillion, bleeding index PBI, depth of periodontal pockets. Radiovisiography survey was carried out before treatment and after 12 months, measuring the profile density of X-ray images (PDX) bone intraalveolar septum.

**Result and discussion:** the impact and Vector PDT therapy for periodontal tissue and classical treatment regimen in patients with GP traced the dynamics of clinical and radiovisiography indicators.

In the application of the proposed treatment results were significantly better than the traditional. Oral hygiene status in group A improved to  $4,08 \pm 0,03$  point, while in group B - on  $3,79 \pm 0,02$  score. PBI index in group A decreased to  $1,75 \pm 0,04$  units and in group B - on  $1,64 \pm 0,013$  units. Patients core group of deep periodontal pockets decreased by  $1,35 \pm 0,03$  mm and control - on  $0,78 \pm 0,05$  mm. Index PDX in patients with GP initial stages of progress increased by 14, 15%, and in patients with I-II stages of progress - by 18.65%.

**Conclusion:** the application of Vector and PDT in patients with GP achieved reached positive clinical results that were confirmed radiographically.

Danylo Halytskyi National Medical University **Ethical Committee Approval:** 21.02.2012 protocol № 61/12.

## **Normalization of functional occlusion in patients with excessive tooth abrasion**

Rybert Yu.O., Magera N.S.

Danylo Halytsky Lviv National Medical University

Postgraduate education faculty, therapeutic dentistry department

n.magera@list.ru

**Keywords:** excessive tooth abrasion, functional occlusion, axiography.

**Introduction:** The average rate of excessive tooth abrasion (ETA) in patients who seek orthopedic care in Ukraine is 14%. ETA leads to disruption in functional occlusion, which can trigger the destabilization of the entire masticatory system.

**Methods:** Clinical examination, axiography, assessment of functional occlusion in the articulator.

**Results:** The study involved 32 patients with ETA aged 17 to 80, 21 of them (65.6%) being males and 11 (34.4%) females. 12 (37.5%) patients revealed generalized tooth abrasion, 20 (62.5%) - a local one that was associated with occlusal problems: orthodontic disorders, multiple tooth loss, iatrogeny, irrational prosthetics, direct restoration of masticatory surfaces of molars. Depending on the causes, treatment of ETA was carried out in several stages: restoration of interalveolar height, guiding of incisors and canines using occlusal splint, orthodontic treatment (splint-line therapy), and computer generated simulation of orthopedic structures in the virtual articulator, temporary and permanent prosthetics and manufacture of the structures using CAD/CAM technologies in digital milling machines.

**Discussion:** Comprehensive study of masticatory system in patients with ETA can objectively evaluate all dysfunctions of its elements. Suggested diagnostic algorithm enables to individualize therapy for ETA patients. Digital technology of functional occlusion modeling and production of orthopaedic structures to treat ETA enable optimal normalization of masticatory system function and elimination or prevention of temporomandibular disorders.

**Conclusion:** Orthodontic treatment should be carried out in several stages, which definitely have to include diagnostics in articulators in centric relation of jaws, and performance of occlusal therapy using splints. CAD/CAM systems enable accurate reproduction occlusal-articulation relationship.

**Sources of research support:** no financial support, grants.

**Acknowledgements** to academic supervisors.

**Ethical Committee:** №4, april 20,2015.



## The Structure of Dentomaxillary Anomalies in Children of Lviv Region

Miskiv A.L.

Pediatric Dentistry Department, Danylo Halytsky Lviv National Medical University

Pekarska str.69b

Email: [and80\\_80@mail.ru](mailto:and80_80@mail.ru)

**Key words:** anomalies of occlusion and individual teeth, children.

**Background:** One of the main tasks of modern dentistry is the organization of providing of orthodontic assistance to children. The numerous studies in the recent years demonstrate that due to the unfavorable environmental conditions and socio-economic situation the development of dental abnormalities increases.

**The aim of this research** is to study the prevalence and the structure of dentomaxillary anomalies in children of the school age living in Lviv region.

**Object and research methods.** For the estimation of prevalence and structure of dentomaxillary anomalies, the epidemiological examination of 891 children, studying in secondary schools of Lviv region was held. The examination was conducted in the key age groups – 7, 12 and 15 years.

**Results of the research and their discussion.** Among the anomalies of occlusion in the different age groups the distal and deep occlusion were with high frequency, that, in middle, presents  $30,58 \pm 4,99$  % and  $28,23 \pm 4,88$  % respectively. The cross and primacy occlusion were diagnosed considerably less frequently ( $11,76 \pm 3,49$  % and  $10,58 \pm 3,33$  % respectively), and the open occlusion had the lowest index ( $9,41 \pm 3,16$  %). The analysis of structure of anomalies of occlusion in the age aspect have showed, that in both 7-years old girls and boys the distal and deep occlusion were noted with the same frequency. A special attention is turned by the significant increase of distal and deep occlusion in the 12 year-old girls, that is, in middle,  $47,05 \pm 12,10$  % and  $41,17 \pm 11,93$  %, respectively. Among the structure of anomalies of occlusion in the 15 year-old children the significant decrease of the amount of deep occlusion is noted in the girls ( $21,42 \pm 11,84$  %), and an increase of the prevalence of distal occlusion in the boys ( $41,66 \pm 14,23$  %).

**Conclusions.** According to the results of conducted study the database of the prevalence of dentomaxillary anomalies, was conducted and it will provide the working of organizational actions for the provision of orthodontic assistance to the children. The obtained data testify about the necessity of the providence of orthodontic help for the children.

Ethical Committee or Institutional Animal Care and Use Committee Approval: 22.04.2013 №4,

## Vasocorrective Therapy in Complex Treatment of Patients with Generalized Periodontitis

Riznyk Y.B.

Department of Therapeutic Dentistry, Danylo Halytsky Lviv National Medical University, Lviv, Ukraine

Corresponding author: Yuriy Riznyk, e-mail: [yuriyriznyk@gmail.com](mailto:yuriyriznyk@gmail.com)

**Key Words:** endothelium dysfunction, generalized periodontitis, treatment.

**Introduction:** The present-day principles of generalized periodontitis (GP) treatment are based on the knowledge of the main links of pathogenesis and are directed on the appropriate correction of them. The endothelial dysfunction that leads to all kinds of metabolic disorders, provokes the microcirculatory disturbances which, in their turn, attach importance to pathogenesis of GP.

In order to prevent the development of endothelial dysfunction (ED) of the periodontium vessels, to slow down the remodelling and hemorheological disorders of periodontium, we applied the new domestic medicine “Corvitin” with a wide spectrum of pharmacological action. “Corvitin” possesses the capillaroprotective, antioxidant and immunomodulatory action.

**Methods:** 75 patients with chronic GP, I and II levels of severity, 34-54 years of age, were under our supervision. In the main group that numbered 40 persons along with the basic therapy, the polymeric dental film with “Corvitin” was applied (patent of Ukraine 59724). It was placed on the surface of the gingival mucosal membrane. To achieve a general influence on the organism the granulated “Quercetin” was administered over a period of one month. 35 persons from the comparison group underwent the course of traditional treatment. Patients were examined before and after therapy, employing clinical, paraclinical and immunobiochemical methods of investigation.

To study the mechanism of ED the endothelin-1 (ET-1) levels and proinflammatory IL-1 $\beta$ , IL-6 and TNF- $\alpha$  cytokines in the oral fluid were studied. The indices were determined prior to treatment, after completing the course of treatment and in 6 months after the treatment.

**Results and discussion:** In consequence of our research, we succeeded to find out the positive influence of pathogenetic treatment with the use of capillaroprotectors. In patients who were examined before the treatment, the increased levels of ET-1 vasoconstrictor and IL-1 $\beta$ , IL-6 and TNF- $\alpha$  proinflammatory cytokines in the oral fluid exceed 2-2,5 times. After completing the course of treatment, the ET-1 and cytokine profile indices in patients from the main group practically conform the level of the healthy individuals.

**Conclusions:** The results of our research testify to the fact that the application of capillaroprotectors in complex treatment of GP patients contributes to normalization of the metabolic, microcirculatory and healing processes of the periodontal tissues. This is confirmed by the reduction of the ET-1 level and proinflammatory cytokines IL-1 $\beta$ , IL-6 and TNF- $\alpha$  in the oral fluid of GP patients.

The analysis of the obtained results after the treatment made it possible to recommend the proposed method for treatment in clinical periodontics.

Financial supports or grants were not used for this research.

Danylo Halytsky Lviv National Medical University **Ethical Committee Approval: 22.04.2013 protocol №4.**

## **Condition of periodontal tissues in young persons with deforming dorsopathies.**

Sloboda M.T.

Danylo Halatsky Lviv National Medical University, Preventive Dentistry Department of Post Diploma Education Faculty

Email: dr.maryana.sloboda@gmail.com

**Keywords:** young persons, periodontal diseases, deforming dorsopathies.

**Introduction.** Periodontal diseases and their prevalence in young age are actual problems in dentistry. In spite of numerous studies of various aspects of the etiology, pathogenesis and treatment of periodontal diseases, insufficient attention is paid to elaboration of criteria for preclinical and early diagnosis of development in order to improve preventive measures. Actuality caused by negative impact of comorbid conditions on oral cavity, from which at a young age is one of the most common are lesions of the musculoskeletal system.

**Methods.** For an objective assessment of the health of young people was thoroughly studied medical card and conclusion of neurologist. Dental examination included: life history, examination, probing, percussion, palpation. Examination of patients with periodontal diseases was to determine the form, the severity, the nature of the disease, and identify common local etiological and pathogenetic factors.

**Results.** Dental and neurological examination of 600 young people revealed different types of deforming dorsopathies in 33% of patients (198 people), of which in 104 patients (52.54%) diagnosed periodontal diseases. In contrast, periodontal diseases from 402 young people without deforming dorsopathies was in 123 patients (30.6%).

**Discussion.** Results of research indicated significantly higher levels of periodontal diseases in patients with deforming dorsopathies and impact of comorbidity on their intensity at a young age.

**Conclusion.** The emergence and exacerbation of periodontal diseases associated with deforming dorsopathies.

**Source(s) of research support:** don't have financial support, grant

**Acknowledgements** to my supervisor prof. Taras Zabolotnyy

**Ethical Committee:** №2, 16.02.2015y.

## **Asymmetry of light conductivity as a criterion for diagnosis of productive processes in the maxillary sinuses.**

Sorokivsky I. S.<sup>1</sup>, Got' I. M.<sup>1</sup>, Rykhlyuk S. V.<sup>2</sup>

<sup>1</sup> Danylo Halytsky Lviv National Medical University, Department of Surgical Dentistry and Maxillofacial Surgery ;

<sup>2</sup> Ivan Franko Lviv National University, Department of Optoelectronics and Information Technologies.

Corresponding author: Ivan Sorokivsky, Ivan.Sorokivsky@gmail.com

**Keywords:** maxillary sinus, transillumination.

**Introduction.** Computed tomography and endoscopic examination are considered to be the most informative methods for maxillary sinus (MS) pathology diagnostics. However, these methods are not deprived of the disadvantages and may be unacceptable in certain clinical situations.

This study **aims** to improve the method of MS transillumination.

**Materials and methods.** Twenty patients with chronic odontogenic maxillary sinusitis were involved into the study as the primary group and 14 patients without pathology of MS as comparison group. All patients gave informative consent to be included in the investigation. Ethical Committee approval: Danylo Halytsky Lviv National Medical University, №5 from 20.05.2013.

The difference between right and left sinuses pneumatization was calculated using the CT scans of the paranasal sinuses and interpreted in pneumatization asymmetry index (PAI).

To determine the MS light conductivity has been designed device that consists of a white light source and two digital cameras close-mounted on binocular opaque mask. A beam of light projected through the palatal wall of MS on both sides alternately in the direction of eyeballs across the maxillary sinuses. The difference in reaction of pupils to light stimulus has been registered and processed using specially designed software and interpreted as light conductivity asymmetry index (LCAI).

**Results and discussion.** In the comparison group average PAI was 5.7% and 1.2% LCAI. In the study group in patients with PAI > 14% there was detected LCAI > 8.3% and further increase of the PAI up to 76% leads to LCAI increasing. When PAI > 76% LCAI varies slightly and stays in the range of 56.4%-63.2%. Therefore is established that asymmetry of MS light conductivity is reliable evidence of its pneumatization symmetry violation and LCAI is connected by nonlinear dependence with MS PAI.

**Conclusions.** Determination of MS light conductivity asymmetry may be non-invasive method of MS productive process diagnosis and its results can be used as basis for definition of necessity for appointment of further examinations of the patient.

**No Source(s) of research support in the form of financial support, no grants.**

**Ethical Committee Approval:** Danylo Halytsky Lviv National Medical University, №5 from 20.05.2013.

## **Influence of endodontic treatment on the periodontal status of the patients with endo-perio lesions.**

Holeyko M.V.

Department of Therapeutic Dentistry, Danylo Halytsky Lviv Medical National University, Lviv, Ukraine

Corresponding author: Marta Holeyko, [martaholeyko447@hotmail.com](mailto:martaholeyko447@hotmail.com)

**Key words:** periodontium, endodontium, combined lesion, treatment

**Introduction:** Morphological and functional connection between periodontium and endodontium determine the high level of involvement of these tissues in one pathological process. A perio-endo lesion can have a varied pathogenesis which ranges from quite simple to relatively complex one. Knowledge of these disease processes is essential in coming to the correct diagnosis. This is achievable by careful history taking, examination and the use of special tests. One thing is evident – combined diseases have to be treated including both endodontic and periodontal procedures.

**Methods:** The status of oral cavity of 35 patients with combined apical and marginal periodontitis has been studied and measured by periodontal indices before and during dynamic supervision. Investigation included X-ray examination, pocket depth, indices OHI-S, PMA, PI, PBI. The complex endodontic and periodontal treatment has been worked out in Group 1. The only periodontal treatment was conducted in Group 2.

**Results and discussions:** The patients of Group 1 demonstrated positive dynamic in changes of periodontal indices after complex treatment. We observed also the acceleration of healing process and reduction of exudation period. In Group 2 the elimination of the inflammation in periodontal tissues was achieved in longer time and with less favourable dynamics.

According to obtained data we suppose that endodontic treatment is a necessary and priority part of a comprehensive treatment of endoperio lesions. Termination of pathological processes in the apical periodontium improves status of marginal periodontium, helps to reduce inflammatory reactions in the parodontium to higher extent.

**Conclusions:** Endodontic treatment for patients with combined lesions has the special value: without adequate endodontic treatment it is impossible to count on the prolong remission and stabilizing of the condition of marginal periodontium, on the other hand - imperfect endodontic treatment can lead to worsening of periodontal status already on the early stages of disease.

Source(s) of research support in the form of financial support, grants- own funds

**Ethical Committee Approval:** Danylo Halytsky Lviv Medical National University 29.10.2007, protocol number 8

## **Evaluation of Dental Status of Children Who Live in Territories with Low Fluoride And Iodine Content**

Melnyk V., Horzov L.

Children Dentistry Department, State Higher Educational Establishment «Uzhgorod National University», Uzhgorod, Ukraine

[melnik-volodimir@mail.ru](mailto:melnik-volodimir@mail.ru)

[lyudmila\\_buley@list.ru](mailto:lyudmila_buley@list.ru)

**Key words:** children, fluorine, prevalence, intensity.

**Introduction.** Ukraine is a region which has developed adverse medical and social situation involving naturally caused by iodine deficiency in the biosphere. The problem of micro-and macroelements lack, fluorine and iodine in the Transcarpathian region remain acute today. Iodine deficiency, low content of macro- and microelements in the environment affects not only the disruption of the thyroid gland and organism as a whole, but also the state of dental health of people living in different areas of the region.

**Methods.** We have examined 300 children. They were divided into 2 groups of boys and girls: 144 boys and 156 girls. Examination card were developed on the basis of cards WHO to record research results. We determined the prevalence and intensity of caries. Oral hygiene status of children was assessed by index OHI-S (Green-Vermilion, 1964).

**Results and discussion.** Among 6 years pupils carious lesions of teeth was  $92,8 \pm 2,81\%$  cases. Intensity decay in deciduous teeth was high and amounted to  $4,73 \pm 0,27$  temporary tooth on one examined, and in the alternating bite caries intensity was  $5,44 \pm 0,40$  teeth per pupil. Prevalence of dental caries among 9 years children was  $50,56 \pm 5,30\%$  of all children whose intensity was  $1,40 \pm 0,17$  permanent tooth for one examined. Average index OHI-S in the examined pupils was  $1,98 \pm 0,05$  points, as recommended by WHO is treated as high.

**Conclusion.** It was discovered that prevalence and intensity of dental caries considerably high in children who live in territories with low fluoride and iodine content. Among children 6 years old boys are more affected by caries ( $97,67 \pm 2,30\%$ ), than girls ( $87,80 \pm 5,11\%$ ). Examination data showed that indicator of unsatisfactory oral hygiene found in 105 persons and bad oral hygiene in 62.

The experimental protocols have been approved by the local Ethics Committee (18.03.2015 № 8).

**Additional submission**

**Institute of Cell Biology  
Abstracts for CMJ and  
Palladin Biochemical Journal  
of Ukraine**

## **Antioxidants selenomethionine and D-pantethine modulate anticancer effects of doxorubicin in NK/Ly lymphoma-bearing mice**

Panchuk R.<sup>1</sup>, Skorokhyd N.<sup>1</sup>, Chumak V.<sup>1</sup>, Lehka L.<sup>1</sup>, Omelyanchik S.<sup>2</sup>, Gurinovich V.<sup>2</sup>, Moiseenok A.<sup>2</sup>, Stoika R.<sup>1</sup>

1 –Department of Regulation of Cell Proliferation and Apoptosis, Institute of Cell Biology NAS of Ukraine, Dragomanov Str 14/16, 79005, Lviv, Ukraine

2 –Department of Nutrition, State Institution "Institute of Biochemistry of biologically active compounds NAS of Belarus", Boulevard of Lenin Komsomol 50, 230030, Grodno, Belarus

Corresponding author: [rpanchuk@ukr.net](mailto:rpanchuk@ukr.net)

**Keywords:** antioxidants, selenomethionine, D-pantethine, doxorubicin, NK/Ly lymphoma, anticancer drugs

**Introduction:** Previously we have reported (Panchuk et al, CMJ, 2014) significant modulatory effect of novel antioxidants on cytotoxic activity of anticancer drug doxorubicin (Dx) *in vitro* towards various tumor cell lines. The aim of current study was to investigate therapeutic effect of joint application of selenomethionine (SeMet) and/or D-pantethine with Dx *in vivo* on healthy and tumor-bearing mice with NK/Ly lymphoma. Impact of this chemotherapy scheme on animal viability, blood profile, hepatotoxicity, glutathione level and activity of glutathione-converting enzymes in animal tissues was studied and compared to the action of Dx alone.

**Methods:** Hematological profile of animals was studied by analysis of blood smears under the Evolution 300 Trino microscope (Delta Optical, Poland). Hepatotoxicity of studied drugs was evaluated by study of activity of ALT/AST enzymes (De Ritis ratio), analysis of coenzyme A fractions was done by McDougal assay, glutathione level in animal tissues was measured colorimetrically with Ellman reagent, and activity of glutathione reductase, transferase and peroxidase was measured using standard biochemical assays.

**Results and Discussion:** SeMet and D-pantethine greatly reduced side effects of Dx *in vivo* on healthy (control) animals, compensating major weight loss (observed for Dx treatment) and restored levels of leucocytes and erythrocytes to control level. Additionally, animal treatment with SeMet and D-pantethine normalized liver status in Dx-treated animals, lowering De Ritis ratio from 2,7 (Dx) to 2,2 (compared to 1,9 in control). In tumor-bearing animals Dx led to increase in GSH level in heart and number of disulfide groups in kidneys, while SeMet reverted there indexes to basal level. Dx also led to decrease in glutathione reductase and glutathione peroxidase level in kidneys, and SeMet restored them to control. On contrary, D-pantethine was able to normalize acid-soluble fraction of coenzyme A in liver of tumor bearing animals, which was significantly decreased by Dx.

**Conclusions:** Both studied antioxidants were able to partially reverse side effects of Dx on normal tissues of tumor-bearing animals and thus significantly increase therapeutic efficiency of this drug towards NK/Ly lymphoma.

**Approval of Commission of Bioethical Expertise of Institute of Cell Biology NASU:**  
№ 9/2014 from 1.09.2014

**Acknowledgement:** Support of the State Funds of Fundamental Research of Ukraine and Belarus (bilateral project #F54/185-2013), Cedars Sinai Medical Center's International Research and Innovation Management Program, the Association for Regional Cooperation in the Fields of Health, Science and Technology (RECOOP HST Association) acknowledged.



**Palladin Institute of  
Chemistry Abstracts for CMJ  
and Palladin Biochemical  
Journal of Ukraine**

## Carbon nanoparticles as fluorescent probes for apoptosis detection

*Mariia Dekaliuk, Kyrylo Pyshev, Alexander Demchenko*

Laboratory of Nanobiotechnologies, Palladin Institute of Biochemistry of the NAS of Ukraine,  
Kiev

mariiadekaliuk@gmail.com

*Key words: Carbon nanoparticles, cell imaging, apoptosis, fixation*

### Introduction

Here we report on a new cheap approach for express detection of apoptosis in live and fixed cells by flow cytometry and microscopy methods applying labeling with carbon nanoparticles.

Recently discovered inorganic carbon nanoparticles (“C-dots”) due to their excellent fluorescence characteristics and biocompatibility have ample opportunities for their use in imaging and functional transformations in living cells. The focus of our research was to determine the possibility of using C-dots as the easily available probes for apoptotic cells detection.

### Methods

The carbon nanoparticles were prepared from alanine, citric acid, urea, etc by hydrothermal treatment at 180 °C. The studies were performed with adherent epithelial Vero and HeLa cell lines (ATCC).

### Results

As the fluorescent material, obtained structures are brightly fluorescent in the visible region, soluble in various organic solvents, stable at different pH and are non-toxic for the cell cultures. Two groups of cell were provided: living (intact) and apoptotic (camptothecin-treated) in both cell lines. Both groups were incubated with C-dots for an hour and all the changes were analyzed with spectrofluorometry, flow cytometry and confocal microscopy. We show that apoptotic cells accumulate significantly larger number of these fluorescent nanoparticles than living cells. Flow cytometry analysis of apoptotic cells stained with them showed higher fluorescence signal than was provided by intact cells. Also marked changes were observed in the fluorescent intensity of C-dots localized inside apoptotic cells – they are additionally accumulated in the area of plasma membrane, which was never observed in living cells. Such effect was reproducibly observed with the both cell lines, and different types of applied C-dots.

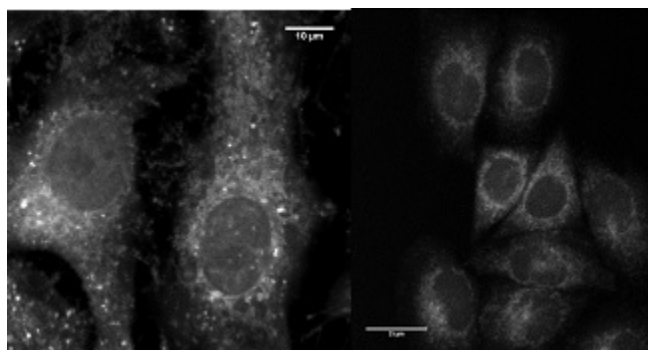

Confocal imaging of live Vero cells (left) and HeLa cells (right) incubated with carbon nanoparticles during 1 hour (excitation 405 nm).

### Discussion and Conclusion

Thus, we suggest simple and efficient method of detecting apoptosis. Its main advantage is the use of easily synthesized fluorescent nanoparticles, which do not require further modifications.

### References

- (1) Dekaliuk M. et al., Phys. Chem. Chem. Phys., 2014,16, 16075-16084
- (2) Ghosh S. et al., Nano Lett., 2014, 14 (10), pp 5656–5661
- (3) Borisova T. et al, Int. J. Biochem. Cell Biol., 2015 (59), 203-215

### **An inhibitory action of N-stearoylethanolamine on aggregation of human platelets**

Hudz' Ie.A., Chernyshenko V.O., Kasatkina L.A.

*Palladin Institute of Biochemistry, NAS of Ukraine*

Corresponding author: Iehor Hudz', e-mail: goudz@mail.ru

**Keywords:** N-stearoylethanolamine, haemostasis, platelets, aggregation, anti-platelet agents.

**Introduction:** N-stearoylethanolamine (NSE), a lipid mediator that belongs to the N-acylolethanolamines family, possesses an anti-inflammatory, hypoglycemic and antitoxic action. The aim was to evaluate the effect of NSE on activation and aggregation of human platelets *in vivo*.

**Methods:** Platelets were obtained from healthy volunteers. In aggregation measurements human platelet rich plasma (PRP) in the presence/absence of NSE ( $10^{-6}$ – $10^{-10}$  M) was activated with ADP. The activation of platelets was registered in fluorescence measurements based on exocytotic release of pH-sensitive dye acridine orange. The shape and granularity of platelets were monitored by flow cytometry.

**Results:** The incubation of human PRP with NSE decreases the platelet aggregation rate from  $45 \pm 5$  to  $21 \pm 4$  % (n=5). This effect was the most prominent in the presence of  $10^{-7}$ – $10^{-8}$  M of NSE. However, the exocytotic release of pH-sensitive probe from activated platelets was not altered in the presence of NSE and equaled  $25 \pm 3$ % (n=5) from accumulated dye. The long-term incubation with NSE did not affect shape/granularity of resting platelets.

**Discussion:** Previously in studies *in vivo* on animal models NSE taken in the concentration range of  $10^{-7}$ – $10^{-8}$  M it was shown to be an effective anti-inflammatory agent. In the present study the same concentrations of NSE were found to be inhibitors of platelet aggregation. Surprisingly, NSE being the inhibitor of ADP-induced aggregation of platelets did not affect platelet activation. It could be an evidence of very specific action of NSE on platelets membrane or signaling processes involved in aggregation.

**Conclusions:** NSE taken in physiologically active concentrations were for the first time shown to be efficient inhibitor of aggregation of human platelets. Thus the recently found anti-platelet effect of NSE complements its anti-inflammatory effect and at the same time allowed us to hypothesize the prospective studies of NSE as a potent anti-thrombotic agent.

**Acknowledgements:** to Dr N. Hula for her support in the development of the ideology of experiments.

**Ethics statement:** The volunteers signed informed consent prior to blood sampling according to the Helsinki declaration. This study was approved by the Palladin Institutes' Ethics Committee (21.08.2015, N3).

## Glutamate regulates platelet release reactions during ADP-stimulated activation

*Ludmila A. Kasatkina*

*The Department of Neurochemistry, Palladin Institute of Biochemistry, NAS of Ukraine,*

*9 Leontovicha Street, Kyiv, 01030, Ukraine. E-mail: [ludmilka.kasatkina@gmail.com](mailto:ludmilka.kasatkina@gmail.com)*

**Keywords:** platelets, AMPA-receptors, platelet degranulation, glutamate release.

**Introduction:** Platelets are able to accumulate glutamate in dense secretory granules via the vesicular glutamate transporters (VGLUT1-2) and express ionotropic and metabotropic glutamate receptors on their plasma membrane. After platelet activation glutamate is released from secretory granules into the surrounding medium and interplatelet space of thrombus. The role of glutamate and the involvement of glutamate receptors in platelet physiology are not fully understood. In this work the agonists of ionotropic glutamate receptors were used to evaluate the role of NMDA-, AMPA/kainate receptors in ADP-induced platelet activation.

**Methods:** To detect platelet activation the registration of degranulation (spectrofluorimetry), the surface exposure of dense granule marker CD63 (confocal imaging), flow cytometry and the endogenous glutamate release assay were applied.

**Results:** It was shown that pre-applications of AMPA (300 mkM) or kainate (200 mkM) but not NMDA (500 mkM) modifies the functional state of platelets and influences subsequent platelet response during stimulated activation (2,5 mkM ADP). The velocity of release of dense granules constituents was  $28,4 \pm 5,2\%$  ( $n=7$ ) higher after pre-application of glutamate and AMPA. Both platelet agonists and antagonists are not able to activate platelets and failed to induce detectable secretion of endogenous glutamate.

**Discussion:** The potentiatory effect of glutamate as a naturally occurring agonist on platelet release reactions is realized mainly via AMPA/kainate receptors. The role of glutamate in thrombus formation is rather accessorial but may play an important regulatory role and be implicated in disorders related to impaired platelet reactivity.

**Conclusions:** It is suggested that glutamate may act on AMPA/kainate receptors as an additional signaling molecule in regulation of platelet reactivity *in vivo* and modulate the strength of platelet response to classical agonists.

**Ethics statement:** Experiments were carried out in accordance with the European Guidelines and were approved by the Institutional Animal Care and Use Committee (03.06.2015, N2).

## Plasma membrane Ca<sup>2+</sup>-pump selective regulators – calix[4]arene C-90 and imidazo[1,2-a]azepine – change parameters of uterus smooth muscles contraction

Mazur<sup>1</sup> Iu.Iu., Veklich<sup>1</sup> T.O., Shkrabak<sup>1</sup> O.A., Gerashchenko<sup>2</sup> I.V., Kosterin<sup>1</sup> S.O.

<sup>1</sup> Department of Muscle Biochemistry, Palladin Institute of Biochemistry of the National Academy of Sciences of Ukraine, Kyiv, Ukraine

<sup>2</sup> Institute of Pharmacology and Toxicology of the National Academy of Medical Sciences, Kyiv, Ukraine

[yuliya.vorona@gmail.com](mailto:yuliya.vorona@gmail.com)

**Key words:** myometrium, calix[4]arene, contractility, imidazo[1,2-a]azepine, oxytocin

**Introduction.** Dysfunction of plasma membrane Mg<sup>2+</sup>,ATP-dependent Ca<sup>2+</sup>-pump (PMCA) activity is often observed in diseases of smooth muscle (SM), i.e., uterus SM: preterm labor, atony, dysmenorrhea, hypo- and hypertonus, prolonged labour. Specific and target influence on PMCA activity may help to improve those pathological conditions. For this purpose we use calix[4]arene C-90 (5,11,17,23-tetra(trifluoro)methyl(phenyl-sulfonylimino)-methylamino-25,26,27,28-tetrapropoxycalix[4]arene) and imidazo[1,2-a]azepine derivate (IFT-35).

**Methods.** Calix[4]arene C-90 was characterized with infrared spectroscopy and nuclear magnetic resonance methods. PMCA enzymatic and Ca<sup>2+</sup>-transport activity was determined on swine myometrium plasma membrane vesicle by measurements of P<sub>i</sub> and by fluorescent probe fluo-4 AM respectively. Contractile activity was induced by hyperpotassium solution or oxytocin and studied isometrically.

**Results.** Calix[4]arene C-90 selectively inhibits enzymatic (by 75%) and transport activity of PMCA (I<sub>0.5</sub>=20.5 μM). PMCA inhibition by different structural components of calix[4]arene C-90 and its structural analogs was estimated. Thus, effectiveness of its action depends on localization and spatial orientation of 4 sulfonilamide groups; and on level of calix[4]arene hydrophobity which can be changed by adding chemical groups to macrocycle lower ring. On contrary, IFT-35 increase PMCA activity by 45% compering to control (A<sub>0.5</sub>=6,40 μM) and slightly elevate its transport activity. Both compounds in oposite way changed amplitude and frequency of myometrium oxytocin-induced contractions *in vitro* and *in vivo*: C-90 (100 μM) increases the velocity in two-fold and IFT-35 (100 μM) decreases in two-fold. Also, calix[4]arene C-90 changes the velocity of SM relaxation and contraction induced by hyperpotassium solution or by oxytocin.

**Conclusion.** From obtained data it was concluded that selective influence on PMCA by proposed compound of C-90 and IFT-35 may be used as a tool for manipulation with SM contraction process and correction of SM pathological dysfunction.

**Acknowledgements.** *We are grateful to our colleague from Institute of Pharmacology and Toxicology and Institute of Organic Chemistry (prof. Kalchenko) for providing reagents and scientific discussion of our results.*

**Institutional Animal Care protocol** were approved by the Animal Care and Use Committee of the Palladin Institute of Biochemistry (Protocol #4 from 21/10/2012).

## Possible mechanisms involved in the development of drug resistance in Ruk/CIN85-overexpressing MCF-7 cells

Pasichnyk G.V.<sup>1</sup>, Horak I.R.<sup>1</sup>, Povorozniuk O.O.<sup>1</sup>, Samoylenko A.A.<sup>1</sup>, Kamińska-Kaczmarek B.<sup>2</sup>, Drobot L.B.<sup>1</sup>

<sup>1</sup> Laboratory of Cell Signaling, Palladin Institute of Biochemistry, National Academy of Sciences of Ukraine, Kiev, Ukraine

<sup>2</sup> Laboratory of Molecular Neurobiology, Nencki Institute of Experimental Biology, Warszawa, Poland

Corresponding author: Ganna Pasichnyk, e-mail: [anya\\_p@meta.ua](mailto:anya_p@meta.ua)

**Key words:** adaptor protein Ruk/CIN85, NF- $\kappa$ B transcription factor, ABC transporters, chemoresistance.

**Introduction:** Resistance to chemotherapeutic agents is a common clinical problem in the treatment of cancer. Multidrug resistance formation is known to be a multifactor process that includes blockage of apoptosis, activation of detoxifying systems and ABC transporters as well as alterations in the cell cycle progression. This biological phenomenon can be realized through aberrant activation of a set of signaling pathways such as MAPK, Akt/PI3K, NF- $\kappa$ B. The aim of this study was to investigate the impact of NF- $\kappa$ B transcription factor in the development of drug resistance in Ruk/CIN85-overexpressing MCF-7 cells.

**Methods:** All experiments were carried out on wild type human breast adenocarcinoma MCF-7 cells, cells with stable overexpression of Ruk<sub>1</sub>/CIN85 (G4 cells) and G4 cells with down regulation of Ruk<sub>1</sub>/CIN85. Such approaches as MTT assay, flow cytometry, inhibitory analysis, luciferase reporter assay and Western blotting were used.

**Results and Discussion:** Cells with overexpression of Ruk<sub>1</sub>/CIN85 were revealed to be more resistant to doxorubicin and etoposide than control cells. To investigate the possible mechanisms involved in increased chemoresistance of Ruk<sub>1</sub>/CIN85-overexpressing cells, the activity of ATP-binding cassette membrane transporters were evaluated by study the efflux of Rhodamine 123 from treated cells. It was revealed that efficiency of Rhodamine 123 elimination was positively correlated with Ruk<sub>1</sub>/CIN85 expression level. In addition, it was demonstrated that Ruk/CIN85-overexpressing MCF-7 cells are characterized by constitutive activity of NF- $\kappa$ B transcription factor that was sensitive to NF- $\kappa$ B inhibitor BAY11-7085. BAY11-7085 did not influence Rhodamine 123 efflux from MCF-7 cells with the highest expression level of Ruk/CIN85 while it decreased the efficiency of Rhodamine 123 elimination from wild type MCF-7 cells. Interestingly, knocking down of Ruk<sub>1</sub>/CIN85 reversed the observed effects of adaptor protein overexpression on MCF-7 drug resistance.

**Conclusion:** Overexpression of Ruk/CIN85 in MCF-7 cells results in the development of drug resistance through non-NF- $\kappa$ B-dependent ABC transporters' activation.

This work was partially supported by the collaboration program between the NAS of Ukraine and Polish Academy of Science, by the target complex interdisciplinary program of the NAS of Ukraine studies "Fundamental basis of molecular and cellular biotechnologies" and the grant of STCU, #5974.

## **An inhibitory action of N-stearoylethanolamine on aggregation of human platelets**

Hudz' Ie.A., Chernyshenko V.O., Kasatkina L.A.

*Palladin Institute of Biochemistry, NAS of Ukraine*

Corresponding author: Iehor Hudz', e-mail: goudz@mail.ru

**Keywords:** N-stearoylethanolamine, haemostasis, platelets, aggregation, anti-platelet agents.

**Introduction:** N-stearoylethanolamine (NSE), a lipid mediator that belongs to the N-acylethanolamines family, possesses an anti-inflammatory, hypoglycemic and antitoxic action. The aim was to evaluate the effect of NSE on activation and aggregation of human platelets *in vivo*.

**Methods:** Platelets were obtained from healthy volunteers. In aggregation measurements human platelet rich plasma (PRP) in the presence/absence of NSE ( $10^{-6}$ – $10^{-10}$  M) was activated with ADP. The activation of platelets was registered in fluorescence measurements based on exocytotic release of pH-sensitive dye acridine orange. The shape and granularity of platelets were monitored by flow cytometry.

**Results:** The incubation of human PRP with NSE decreases the platelet aggregation rate from  $45 \pm 5$  to  $21 \pm 4$  % (n=5). This effect was the most prominent in the presence of  $10^{-7}$ – $10^{-8}$  M of NSE. However, the exocytotic release of pH-sensitive probe from activated platelets was not altered in the presence of NSE and equaled  $25 \pm 3$ % (n=5) from accumulated dye. The long-term incubation with NSE did not affect shape/granularity of resting platelets.

**Discussion:** Previously in studies *in vivo* on animal models NSE taken in the concentration range of  $10^{-7}$ – $10^{-8}$  M it was shown to be an effective anti-inflammatory agent. In the present study the same concentrations of NSE were found to be inhibitors of platelet aggregation. Surprisingly, NSE being the inhibitor of ADP-induced aggregation of platelets did not affect platelet activation. It could be an evidence of very specific action of NSE on platelets membrane or signaling processes involved in aggregation.

**Conclusions:** NSE taken in physiologically active concentrations were for the first time shown to be efficient inhibitor of aggregation of human platelets. Thus the recently found anti-platelet effect of NSE complements its anti-inflammatory effect and at the same time allowed us to hypothesize the prospective studies of NSE as a potent anti-thrombotic agent.

**Acknowledgements:** to Dr N. Hula for her support in the development of the ideology of experiments.

**Ethics statement:** The volunteers signed informed consent prior to blood sampling according to the Helsinki declaration. This study was approved by the Palladin Institutes' Ethics Committee (21.08.2015, N3).

## Mapping of Residues of Fibrinogen Cleaved by Protease II of *Bacillus thuringiensis* var. *israelensis* IMV B-7465

Stohniy E.M., Chernyshenko V.O., Nidialkova N.A., Rebriev A.V.

*Palladin Institute of Biochemistry, NAS of Ukraine*  
*Zabolotny Institute of Microbiology and Virology, NAS of Ukraine*

Corresponding author: Volodymyr Chernyshenko, e-mail: bio.cherv@gmail.com

**Keywords:** protease, *Bacillus thuringiensis*, fibrinogen,  $\alpha$ C-domain

**Introduction:** Proteases are known to have strong specificity to distinct peptide bonds of proteins. The limited proteolysis of macromolecules allows obtaining of the fragments that possess the features or preserve the structure of the whole molecule and could be used in the study of proteins structure and functions. Proteases targeted to fibrinogen and fibrin are of interest as the source for obtaining of physiologically active fragments of fibrin(ogen) and for direct defibrination *in vivo*. That is why the aim of our work was to study the proteolytic action of Protease II (PII) purified from *Bacillus thuringiensis* var. *israelensis* IMV B-7465.

**Methods:** Hydrolysis products of fibrinogen by PII were analysed by SDS-PAGE under reducing conditions with further immunoprobings using the mouse monoclonal 1-6B (anti-A $\alpha$ 509-610) and II-5C (anti-A $\alpha$ 20-78) antibody. MALDI-TOF analysis of fibrinogen hydrolysis products was performed using a Voyager-DE. Results were analyzed by Data Explorer 4.0.0.0.

**Results & Discussion:** SDS-PAGE showed that PII cleaved preferentially the A $\alpha$ -chain of fibrinogen. Western-blot analysis carried out using monoclonal antibodies allowed us to detect the product with apparent molecular weight of 10 kDa that corresponded the C-terminal part of A $\alpha$ -chain of fibrinogen molecule. MALDI-TOF analysis of products of hydrolysis of fibrinogen by PII allowed to detect the main peak occurs at mass/charge (M/Z) ratio of 11 441 Da. According to «Peptide Mass Calculator» this peptide corresponded to fragment A $\alpha$ 505-610 of fibrinogen molecule. It showed that PII cleaves the peptide bond A $\alpha$ Asp-Thr-Ala504-Ser505.

**Conclusions:** Western-blotting using monoclonal antibody and MALDI-TOF analysis showed that PII derived from cultural medium of *B. thuringiensis* var. *israelensis* IMV B-7465 cleaves-off the C-terminal peptide of A $\alpha$ -chain of human fibrinogen. Thus, PII can be used for the obtaining of unique fragments of fibrinogen molecule. As far as  $\alpha$ C-domain contains numerable sites of intermolecular interactions we can consider PII as a prospective agent for the defibrination.

**Acknowledgements:** to Dr L. Varbanets for her support in the development of the ideology of experiments. To Dr E. Lugovskoy and Dr I. Kolesnikova for their help with the production and selection of antibodies used in study.



## Localization of the site of fibrin protofibrils lateral association in coiled-coil region of molecule

Urvant L.P., Lugovska N.E., Makogonenko Y.M., Lugovskoi E.V.

Protein structure and functions department,  
Palladin Institute of Biochemistry, Kyiv, Ukraine

[lpurvant@gmail.com](mailto:lpurvant@gmail.com)

**KEY WORDS:** fibrin, synthetic peptide, protofibrils lateral association.

**AIMS:** Previously we showed that fibrin-specific monoclonal antibody I-3c (monAb I-3c) inhibited the fibrin protofibrils lateral association. We suggested that the epitope of monAb I-3c in coiled-coil region of fibrin coincides with the site involved in protofibrils lateral association. In this work we used the synthetic peptides B $\beta$ 121-138 and its scrambled version, peptides B $\beta$ 109-126 and B $\beta$ 125-135 to localize the site of protofibrils lateral association.

**METHODS:** Turbidity analysis was used to study the effect of synthetic peptides on fibrin polymerization. The interaction between peptides and monAb I-3c was investigated by SPR method using Plasmon-6 device.

**RESULTS:** We investigated the effect of synthetic peptides which corresponded to amino acid sequences of fibrin molecule B $\beta$ 109-126, B $\beta$ 121-138, B $\beta$ 125-135, and the scrambled version of B $\beta$ 121-138 peptides on a binding to monAb I-3c and on the fibrin polymerization process. In SPR analysis was showed that B $\beta$ 121-138 and B $\beta$ 125-135 peptides but not the scrambled version of B $\beta$ 121-138 binds to monAb I-3c, immobilized to a chip. Turbidity data showed that only B $\beta$ 121-138 and B $\beta$ 125-135 peptides caused the 2-fold decrease of the rate of the lateral association of protofibrils at the concentration  $2.2 \times 10^{-4}$  M and  $2.7 \times 10^{-4}$  M, respectively. Both of them decreased the final clot turbidity.

**CONCLUSIONS:** B $\beta$ 125-135 is the site that involved in protofibrils lateral association.

## **Effect of BCG Vaccine on Bone Structure and Metabolism in Rats Under Alimentary Osteoporosis**

ZAITSEVA O., SHANDRENKO S., VELIKY M.\*

*Departments of Metabolism regulation and \*Medical biochemistry,  
Palladin Institute of Biochemistry, National Academy of Sciences of Ukraine, Kyiv  
e-mail: [Zaitseva\\_OV@ukr.net](mailto:Zaitseva_OV@ukr.net)*

*Key words:* BCG, osteoporosis, X-ray analysis, mineral composition, collagen.

### **Introduction**

Today it has become apparent that NO has important effect on bone cells functioning. Because BCG vaccine stimulates the immune system causing NO hyperproduction and owing to recent studies that show non-specific protective BCG effects we decided to investigate BCG effect on bone metabolism in rats under alimentary osteoporosis.

### **Methods**

Osteoporosis model was performed on female Wistar rats by using of a synthetic diet without vitamin D<sub>3</sub> combined with balanced calcium and phosphorus content during 45th days. 3 groups were formed: 1st – control (D<sub>3</sub>-balanced diet), 2nd and 3rd – D<sub>3</sub>-deficiency diet. 3rd group at 30th day was intraperitoneal injected with 10 mg/kg of BCG. X-ray, UHPLC and bone morphology analyses were performed. Plasma and bone minerals content, bone turnover markers and bone collagen content were determined.

### **Results**

Control have normal X-ray image unlike rats with osteoporosis which have structural changes in the knee sites, thorax, forearm and caudal tail vertebrae. Morphology analysis of femur rats with osteoporosis indicates weight decreasing by 47% and length shortening by 32%; vertical femoral head diameter and femur width decreasing by 14% and 18% respectively vs. control. UHPLC analysis of rat's plasma with osteoporosis and BCG showed elevated level of unknown amino acid in 5 times vs. control. Calcium and phosphorus level in bone and plasma was significantly decreased in rats with osteoporosis vs. control. BCG led to increasing of those minerals content by 25% and 17% in bone and decreasing of alkaline phosphatase activity by 40% in plasma. Citric soluble collagen content in rats with osteoporosis was increased by 54% vs. control. BCG caused its decreasing by 48% vs. osteoporosis.

### **Discussion and Conclusion**

Results indicate slowing down of degradation processes under BCG injection. We suggest that NO due to BCG vaccination inhibit osteoclast formation and activity. NO may also form new cross-links in proteins in particular collagen thereby changing its structure and stability.

### **Ethics statement**

The experiment was carried out according to the principles of Helsinki declaration, ratified by *General Ethical Principles for Experiments on Animals* (Ukraine, 2001). The study was approved by the institution's Ethics Committee (Protocol from 21.08.2015, N3).